

DESIGN / CONSTRUCTION

Overwatch Body	304L SS
External Hardware	304L SS
Gaskets	Buna-N
Motor Body	Cast Iron
Shaft Seal	Single Mechanical Seal
Impeller	185mm DIPCUT® Impeller Standard (Vortex or Channel optional)
Maximum Solid Size \varnothing	2.8" (70mm)

MOTOR SPECIFICATIONS

Motor Design	2-Pole, 3-Phase Squirrel-Cage Motor 50Hz/60Hz
Motor Type	TEFC, IP67
Insulation Class	Class F
Motor Protection	Protected by VFD
Service Factor	1.15
Maximum Ambient Temp.	104°F (40°C)
Voltage Tolerance	±10%

MOTOR DATA

Rated Power	230V FLA	460V FLA	575V FLA	Weight *
5.5kW / 7.4HP	20.8	10.4	8.3	379lb (172kg)
7.5kW / 10.1HP	28.2	14.1	11.3	423lb (192kg)
11kW / 14.8HP	41.2	20.6	16.5	569lb (258kg)
15kW / 20.1HP	53	26.5	21.2	732lb (332kg)

DIMENSIONS (largest motor)

Inlet	6" ANSI 150#
Outlet	4" ANSI 150#
H1	14.7" (374mm)
H2	17.5" (445mm)
L	33.6" (854mm)
P	29.5" (750mm)

* Total weight of unit

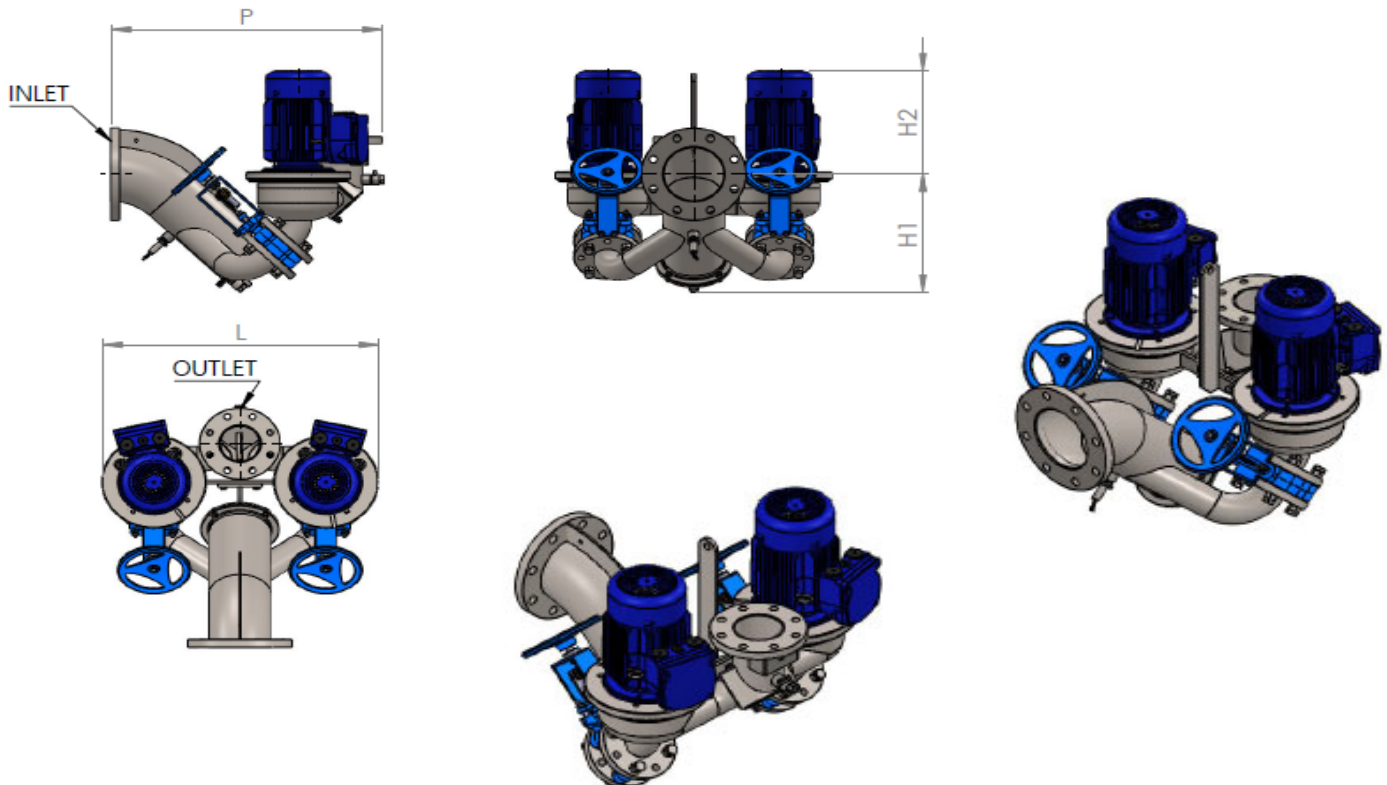

DESIGN / CONSTRUCTION

Body	304L SS
External Hardware	304L SS
Gaskets	Buna-N
Motor Body	Cast Iron
Shaft Seal	Single Mechanical Seal
Impeller	185mm DIPCUT® Impeller Standard (Vortex or Channel optional)
Maximum Solid Size ϕ	2.8" (70mm)

MOTOR SPECIFICATIONS

Motor Design	4-Pole, 3-Phase Squirrel-Cage Motor 50Hz/60Hz
Motor Type	TEFC, IP67
Insulation Class	Class F
Motor Protection	Protected by VFD
Service Factor	1.15
Maximum Ambient Temp.	104°F (40°C)
Voltage Tolerance	±10%

MOTOR DATA

Rated Power	230V FLA	460V FLA	575V FLA	Weight *
3kW / 4HP	13	6.5	5.2	344lb (156kg)
4kW / 5.4HP	16.6	8.3	6.6	375lb (170kg)
5.5kW / 7.4HP	21.6	10.8	8.6	419lb (190kg)

DIMENSIONS (largest motor)

Inlet	6" ANSI 150#
Outlet	4" ANSI 150#
H1	14.7" (374mm)
H2	17.5" (445mm)
L	33.6" (854mm)
P	29.5" (750mm)

* Total weight of unit

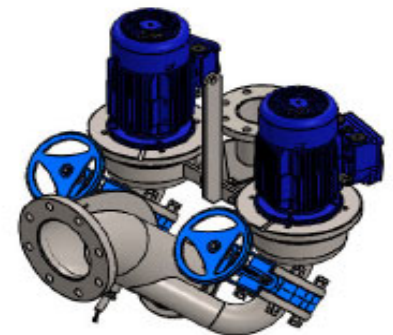
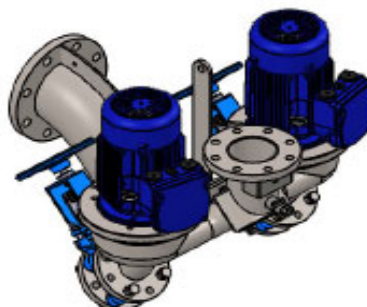
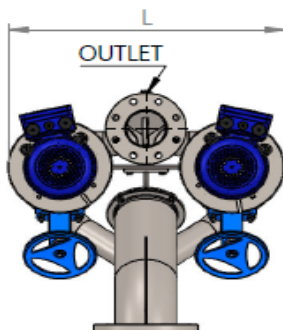
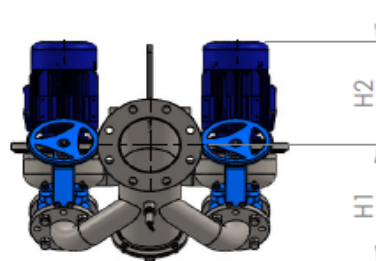
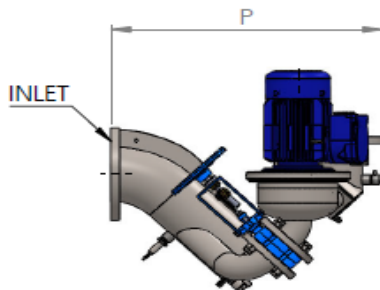

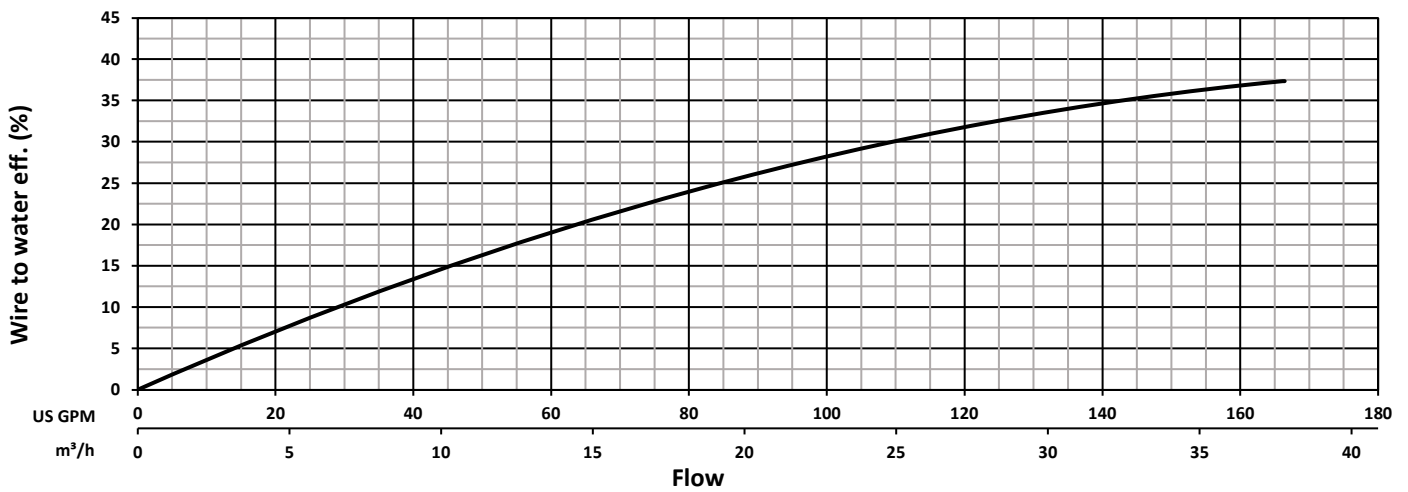
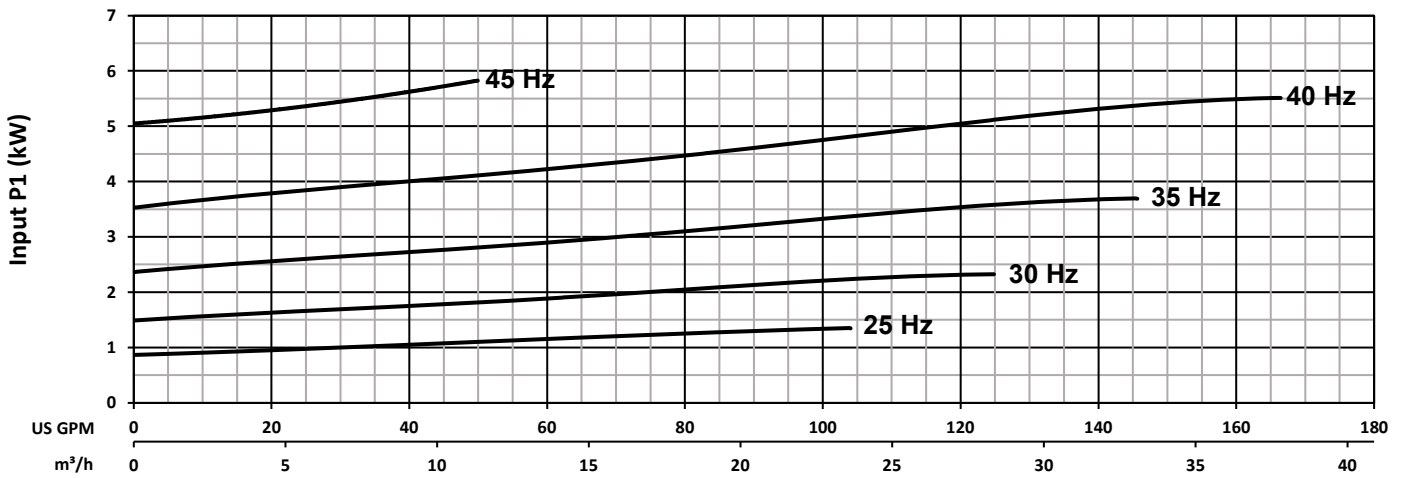
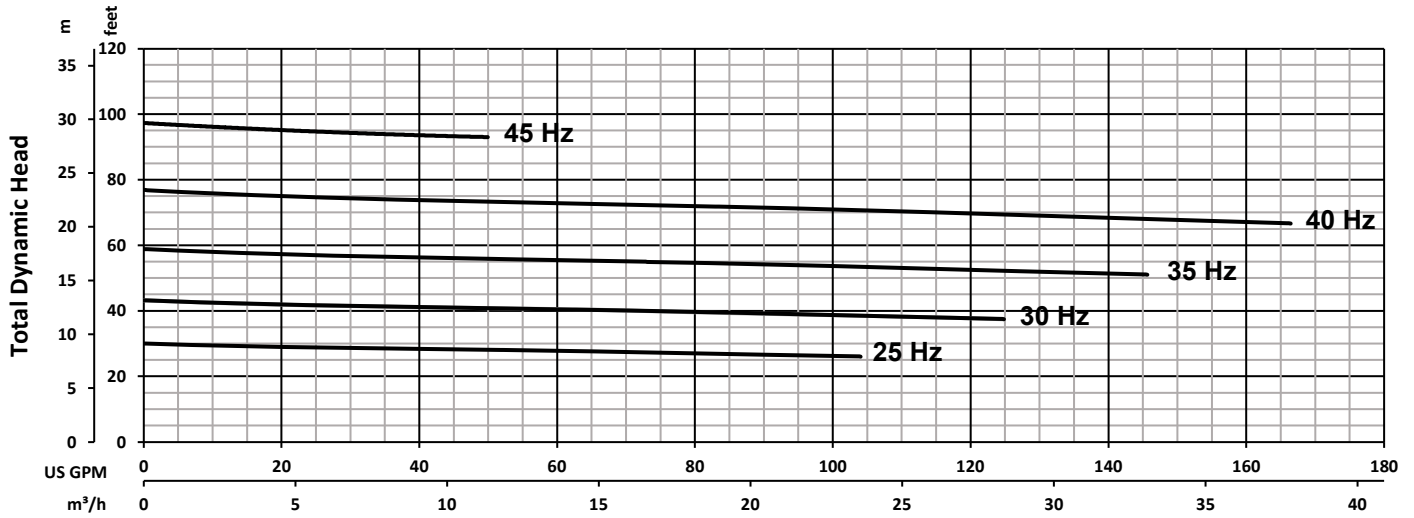

PERFORMANCE CURVE OW31-2VV 5.5kW

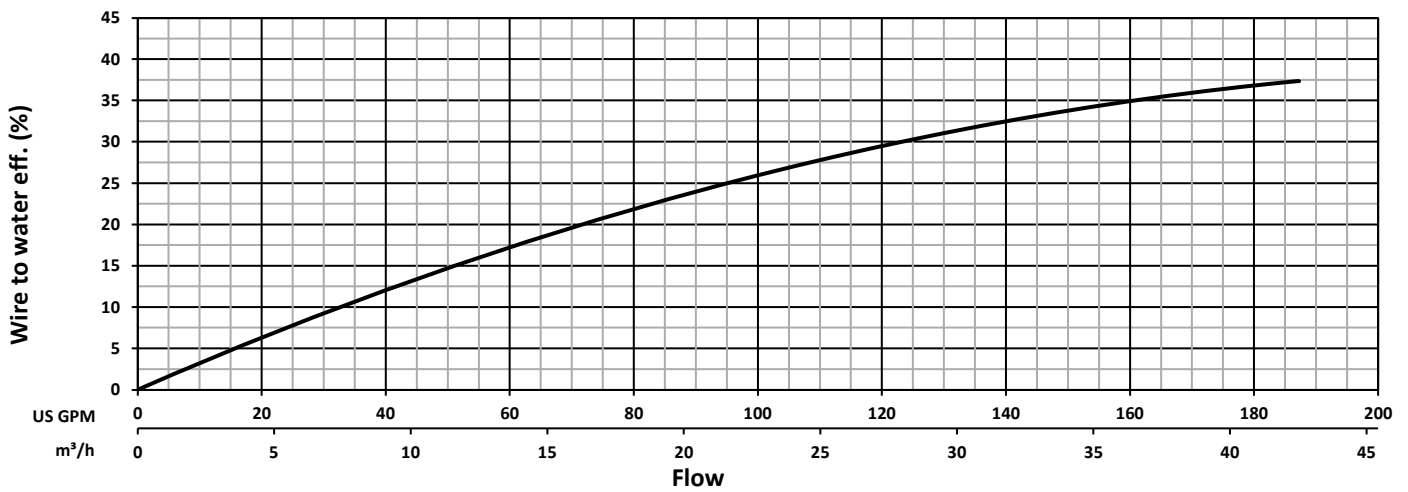
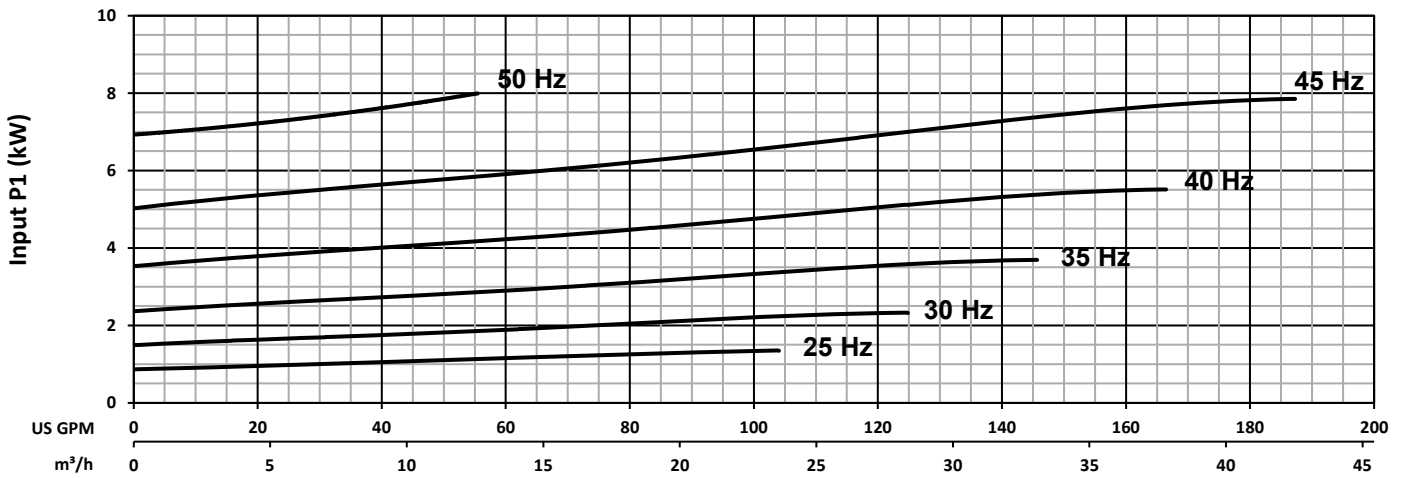
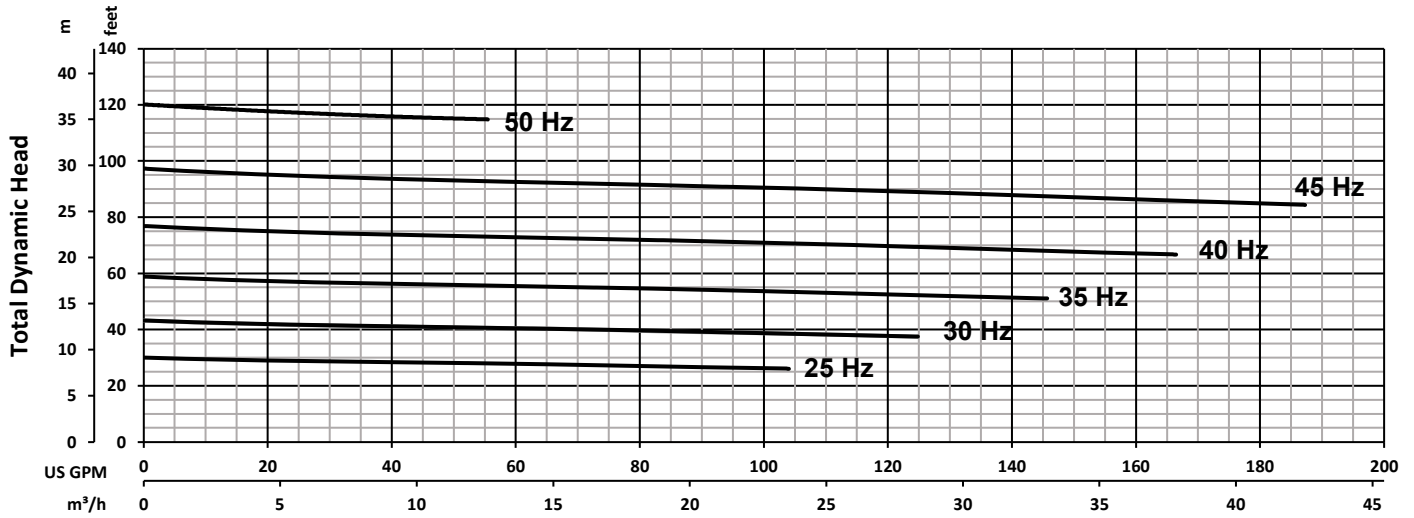

 INDUSTRIAL FLOW SOLUTIONS	PERFORMANCE CURVE			DS-A50-007
	Tested with clean water Test Standard : HI 11.6 Gr 3B		Model	OW31-2VV 5.5kW
			Motor	5.5 kW/7.4 HP
	Tested with clean water Test Standard : HI 11.6 Gr 3B		Impeller Ø	165x30x15mm

PERFORMANCE CURVE OW31-2VV 7.5kW



 INDUSTRIAL FLOW SOLUTIONS	PERFORMANCE CURVE			DS-A50-008	
	Tested with clean water Test Standard : HI 11.6 Gr 3B	Model	OW31-2VV 7.5kW		Rev 1
		Motor	7.5kW / 10.1HP	Poles	2
		Impeller Ø	165x30x15mm	Specifications subject to change without notice	

PERFORMANCE CURVE OW31-2VV 11.0kW

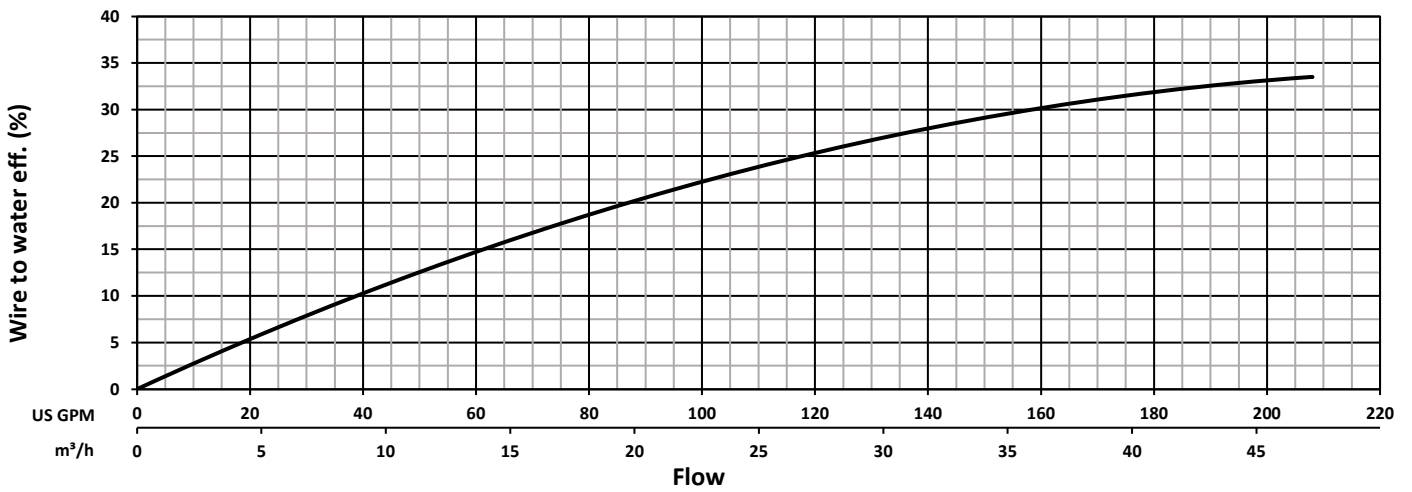
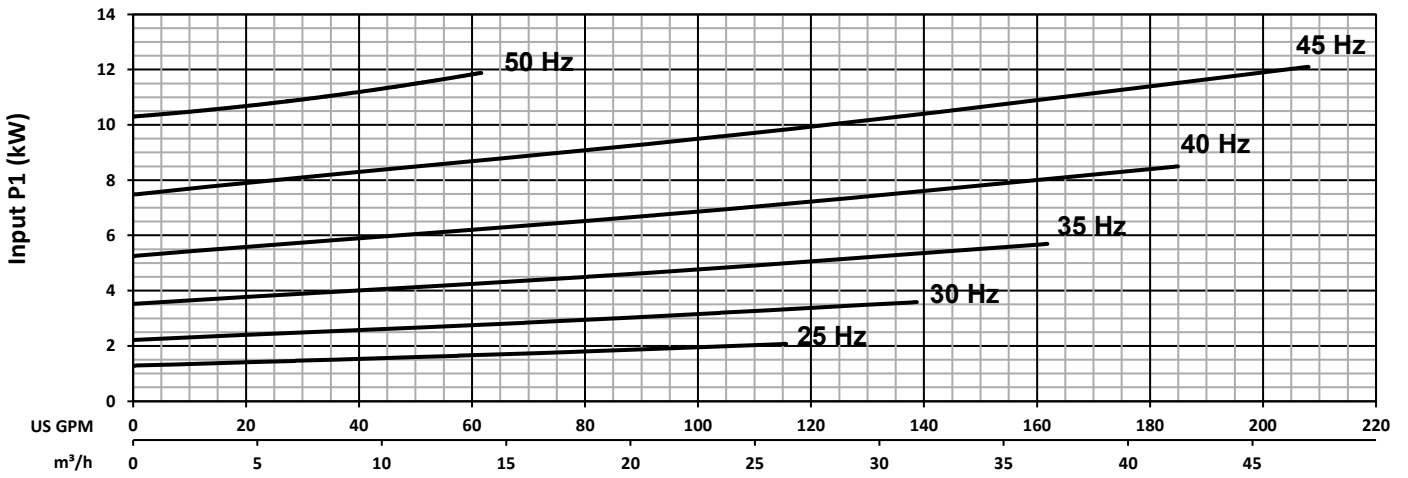
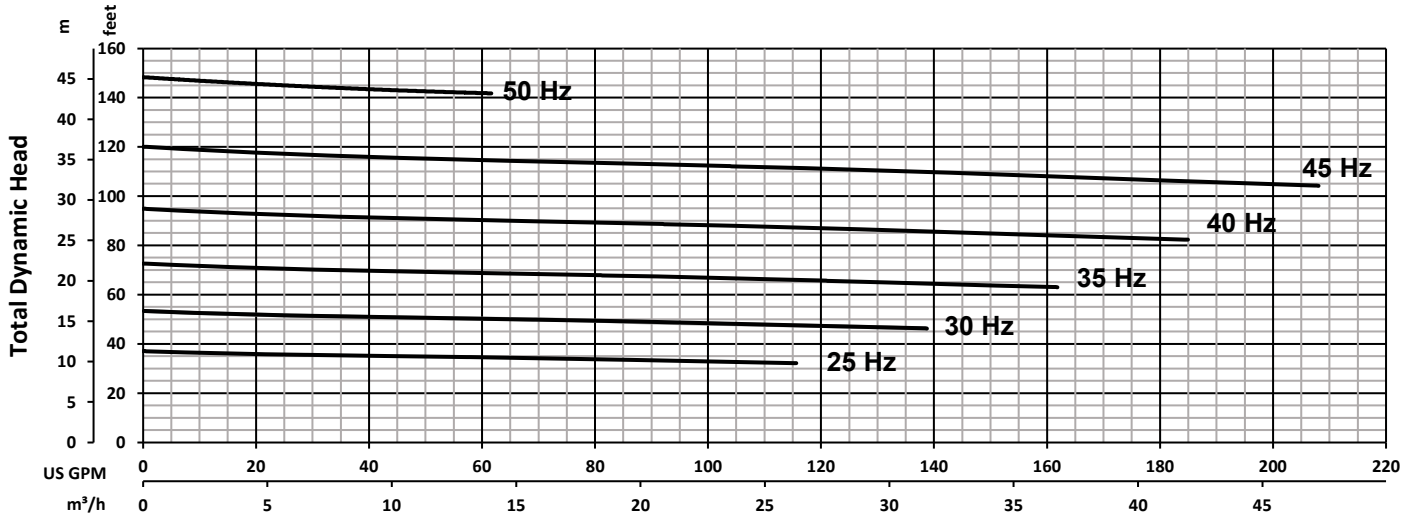

 INDUSTRIAL FLOW SOLUTIONS	PERFORMANCE CURVE			DS-A50-009		
	Tested with clean water Test Standard : HI 11.6 Gr 3B		Model	OW31-2VV 11.0kW		
			Motor	11.0 kW/15 HP	Poles	2
	Impeller Ø	185mm	<small>Specifications subject to change without notice</small>			

PERFORMANCE CURVE OW31-2VV 15.0kW

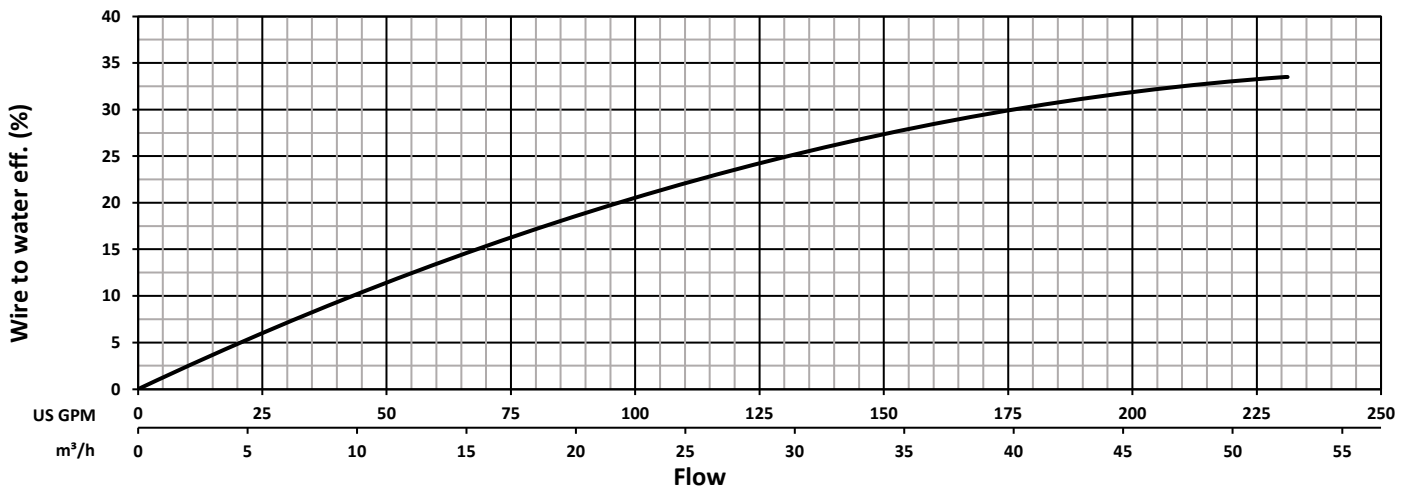
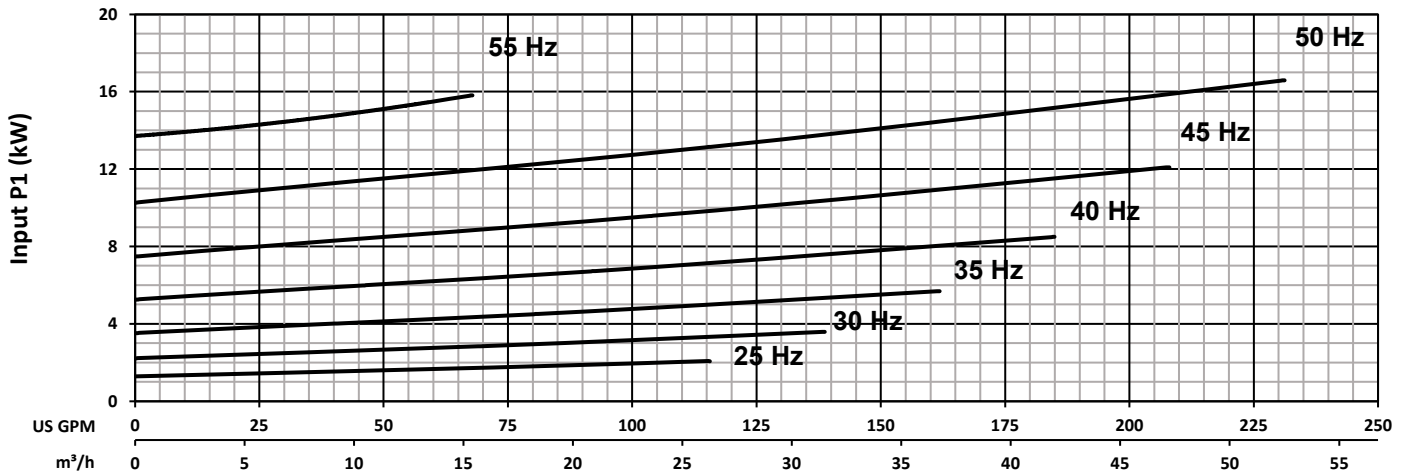
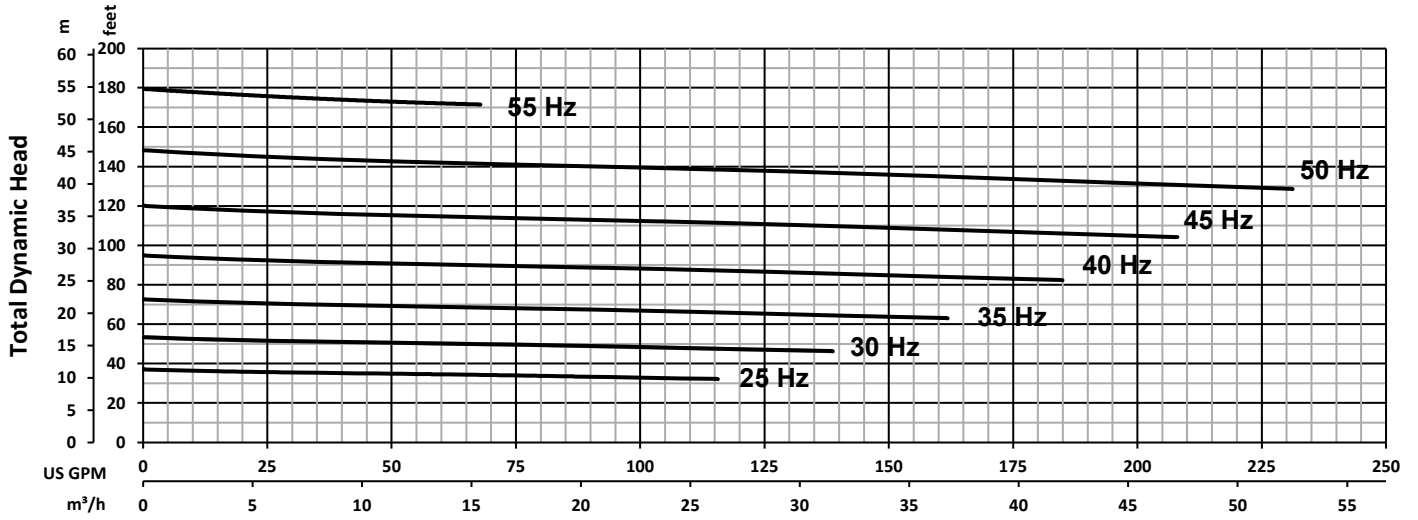

 INDUSTRIAL FLOW SOLUTIONS	PERFORMANCE CURVE			DS-A50-010	
	Tested with clean water Test Standard : HI 11.6 Gr 3B	Model	OW31-2VV 15.0kW		Rev --
		Motor	15.0 kW/20.1 HP	Poles 2	Date 2/27/2020
		Impeller Ø	185mm	Specifications subject to change without notice	

PERFORMANCE CURVE OW31-4VV 3.0kW

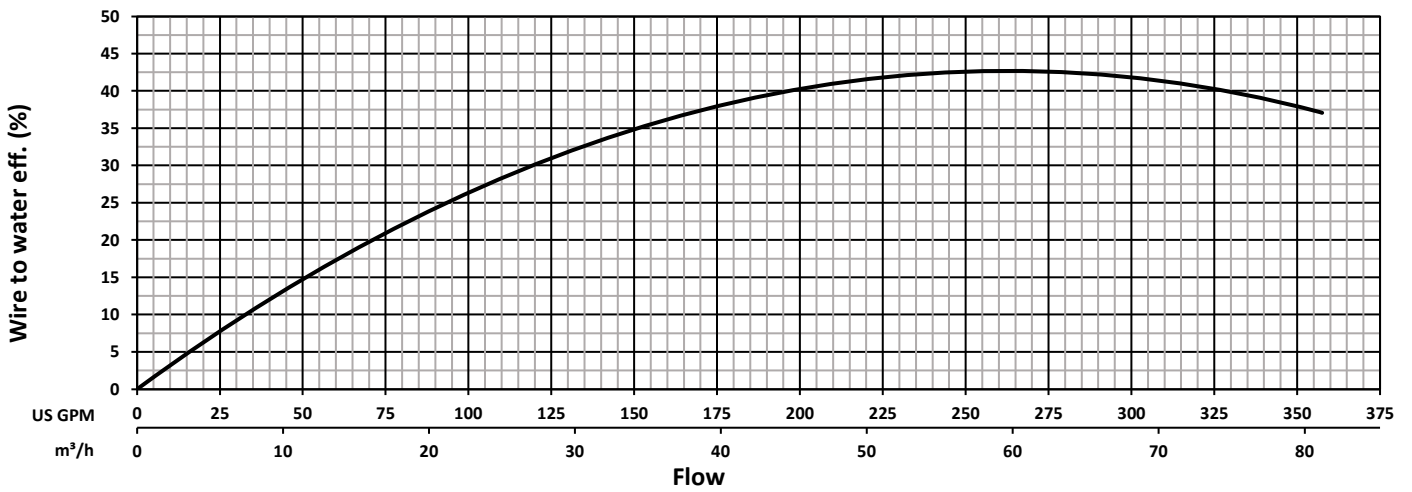
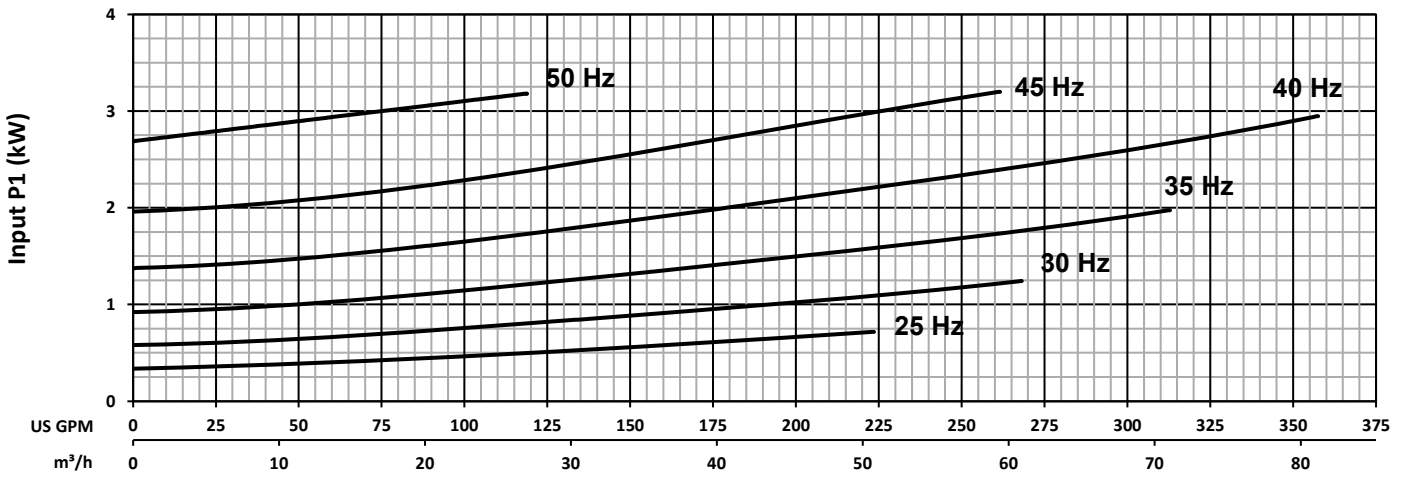
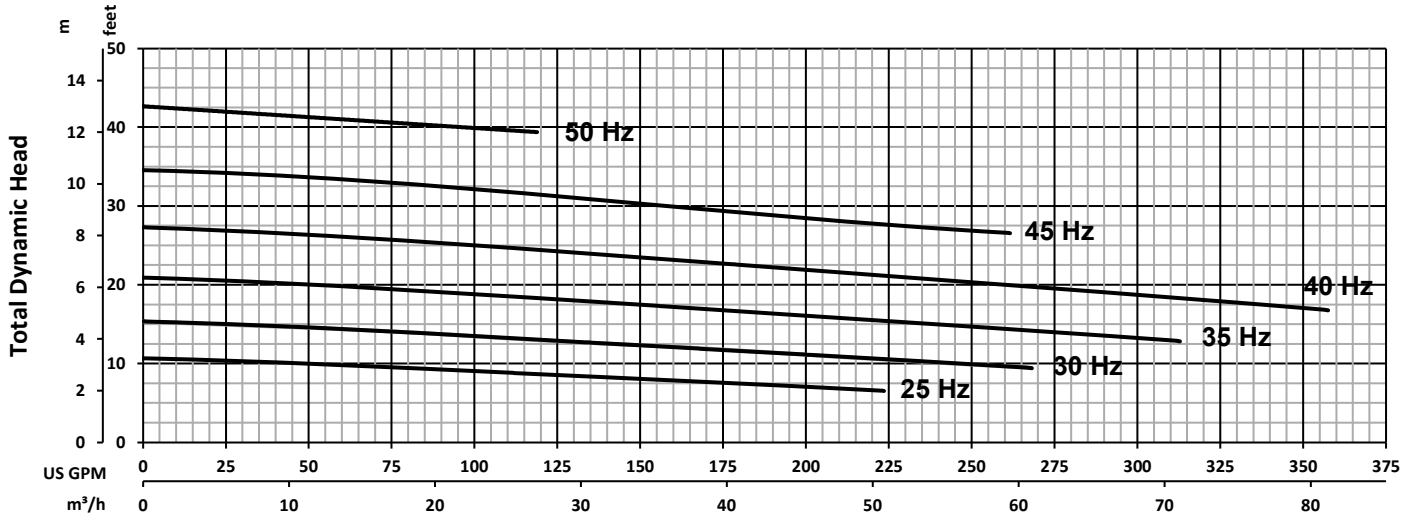

 INDUSTRIAL FLOW SOLUTIONS	PERFORMANCE CURVE			DS-A50-011
	Tested with clean water Test Standard : HI 11.6 Gr 3B		Model	OW31-4VV 3.0kW
			Motor	3.0 kW/4 HP
			Poles	4
		Impeller Ø	185mm	Rev -- Date 2/27/2020 <small>Specifications subject to change without notice</small>

PERFORMANCE CURVE OW31-4VV 4.0kW

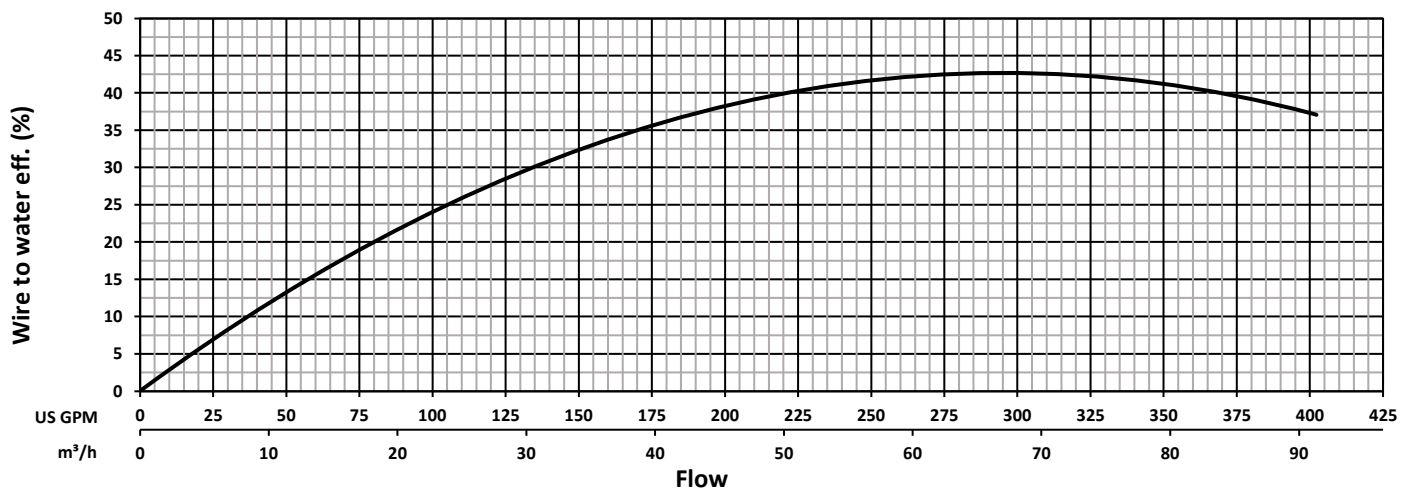
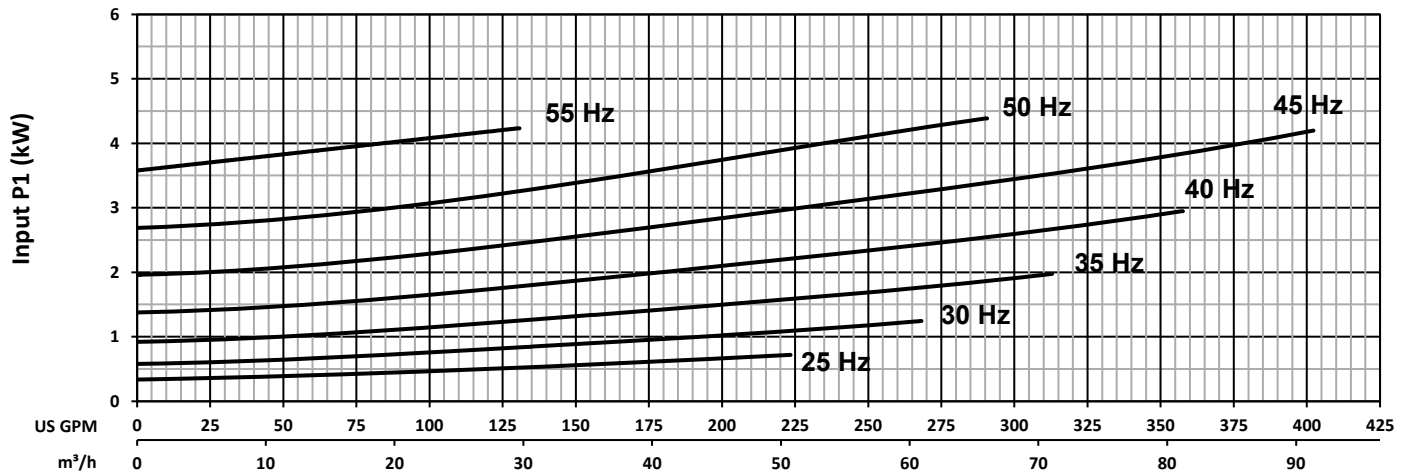
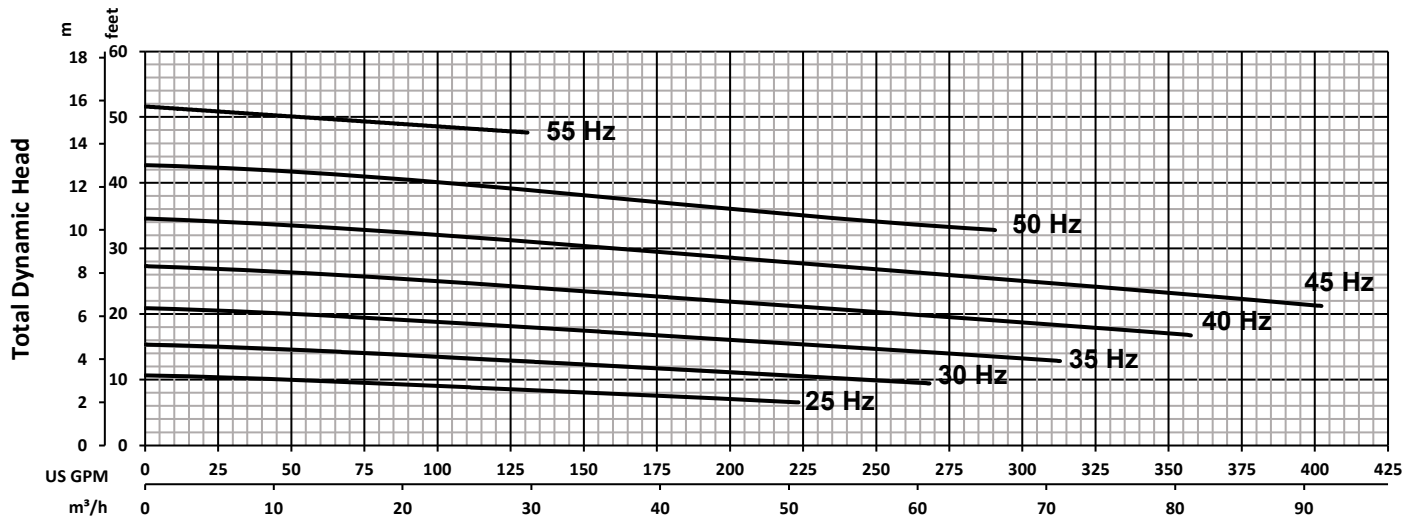

 INDUSTRIAL FLOW SOLUTIONS	PERFORMANCE CURVE			DS-A50-012	
	Tested with clean water Test Standard : HI 11.6 Gr 3B		Model	OW31-4VV 4.0kW	
			Motor	4kW / 5.4HP	Poles 4
			Impeller Ø	185mm	Date 2/27/2020 Specifications subject to change without notice

PERFORMANCE CURVE OW31-4VV 5.5kW

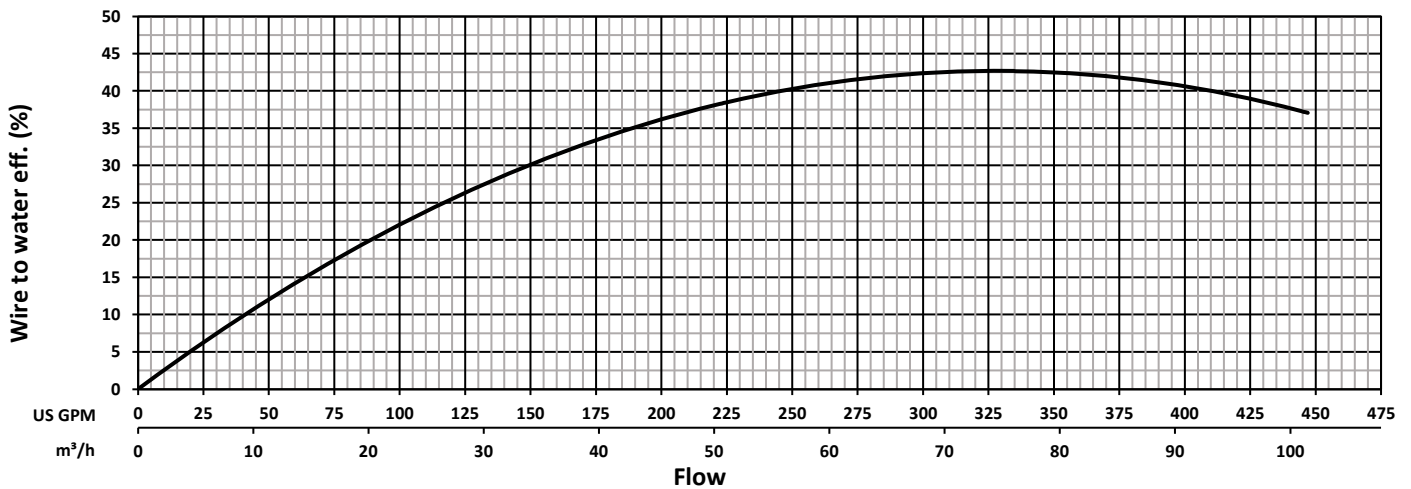
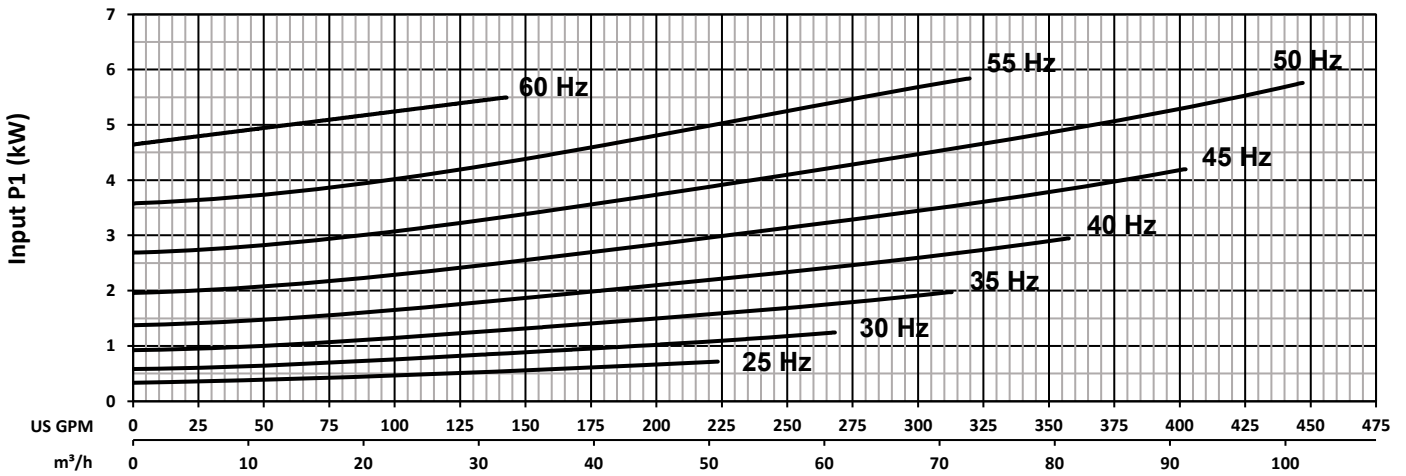
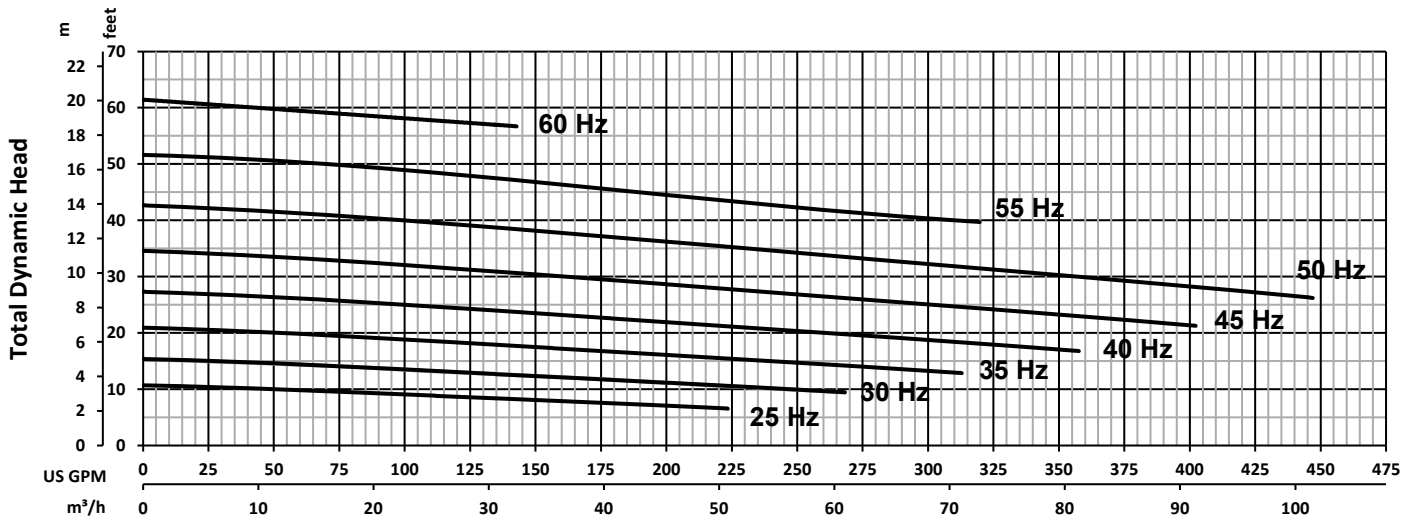

 INDUSTRIAL FLOW SOLUTIONS	PERFORMANCE CURVE			DS-A50-013
	Tested with clean water Test Standard : HI 11.6 Gr 3B		Model OW31-4VV 5.5kW	Rev --
			Motor 5.5kW / 7.4HP	Poles 4
			Impeller Ø 185mm	Date 2/27/2020
Specifications subject to change without notice				