

DESIGN / CONSTRUCTION

Overwatch Body	304L SS
External Hardware	304L SS
Gaskets	Buna-N
Motor Body	Cast Iron
Shaft Seal	Single Mechanical Seal
Impeller	130mm DIPCUT® Impeller Standard (Vortex or Channel optional)
Maximum Solid Size ϕ	2.8" (70mm)

MOTOR SPECIFICATIONS

Motor Design	2-Pole, 3-Phase Squirrel-Cage Motor 50Hz/60Hz
Motor Type	TEFC, IP67
Insulation Class	Class F
Motor Protection	Protected by VFD
Service Factor	1.15
Maximum Ambient Temp.	104°F (40°C)
Voltage Tolerance	±10%

MOTOR DATA

Rated Power	230V FLA	460V FLA	575V FLA	Weight *
4kW / 5.4HP	15.6	7.8	6.2	258lb (117kg)
5.5kW / 7.4HP	20.8	10.4	8.3	287lb (130kg)

DIMENSIONS (largest motor)

Inlet	6" ANSI 150#
Outlet	4" ANSI 150#
H1	13.7" (349mm)
H2	10.1" (256mm)
L	29.8" (756mm)
P	26.8" (680mm)

* Total weight of unit

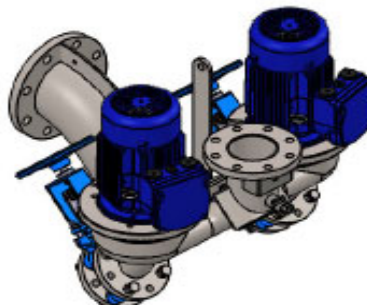
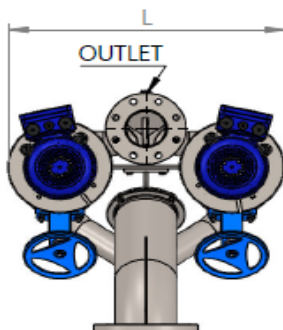
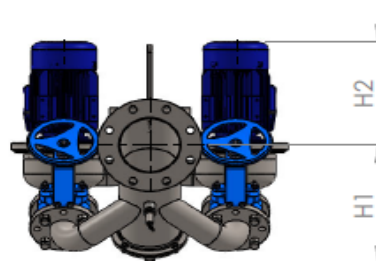
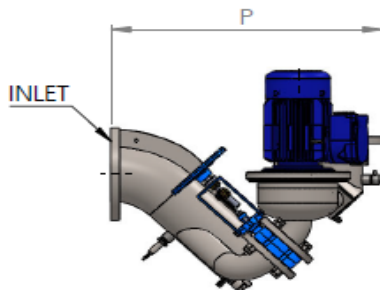

DESIGN / CONSTRUCTION

Body	304L SS
External Hardware	304L SS
Gaskets	Buna-N
Motor Body	Cast Iron
Shaft Seal	Single Mechanical Seal
Impeller	165mm DIPCUT® Impeller Standard (Vortex or Channel optional)
Maximum Solid Size \varnothing	2.8" (70mm)

MOTOR SPECIFICATIONS

Motor Design	4-Pole, 3-Phase Squirrel-Cage Motor 50Hz/60Hz
Motor Type	TEFC, IP67
Insulation Class	Class F
Motor Protection	Protected by VFD
Service Factor	1.15
Maximum Ambient Temp.	104°F (40°C)
Voltage Tolerance	±10%

MOTOR DATA

Rated Power	230V FLA	460V FLA	575V FLA	Weight *
2.2kW / 3HP	9.4	4.7	3.8	190lb (87kg)
3kW / 4HP	13	6.5	5.2	227lb (103kg)
4kW / 5.4HP	16.6	8.3	6.6	258lb (117kg)

DIMENSIONS (largest motor)

Inlet	6" ANSI 150#
Outlet	4" ANSI 150#
H1	13.7" (349mm)
H2	10.1" (256mm)
L	29.8" (756mm)
P	26.8" (680mm)

* Total weight of unit

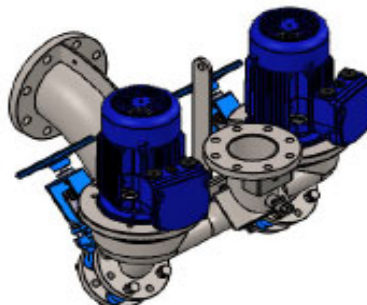
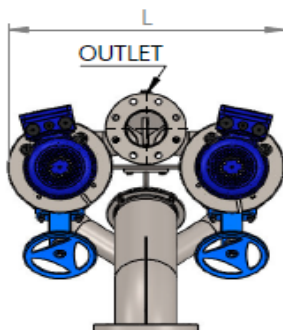
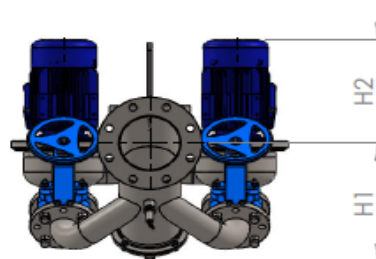
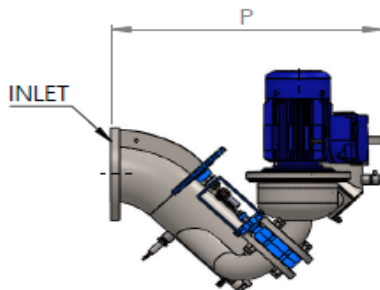

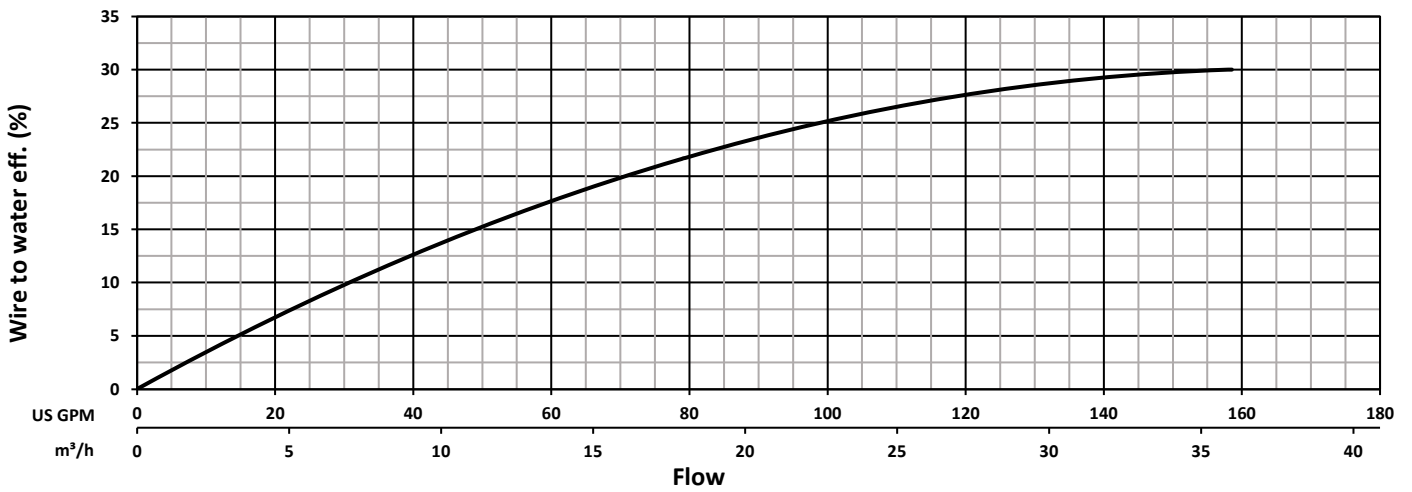
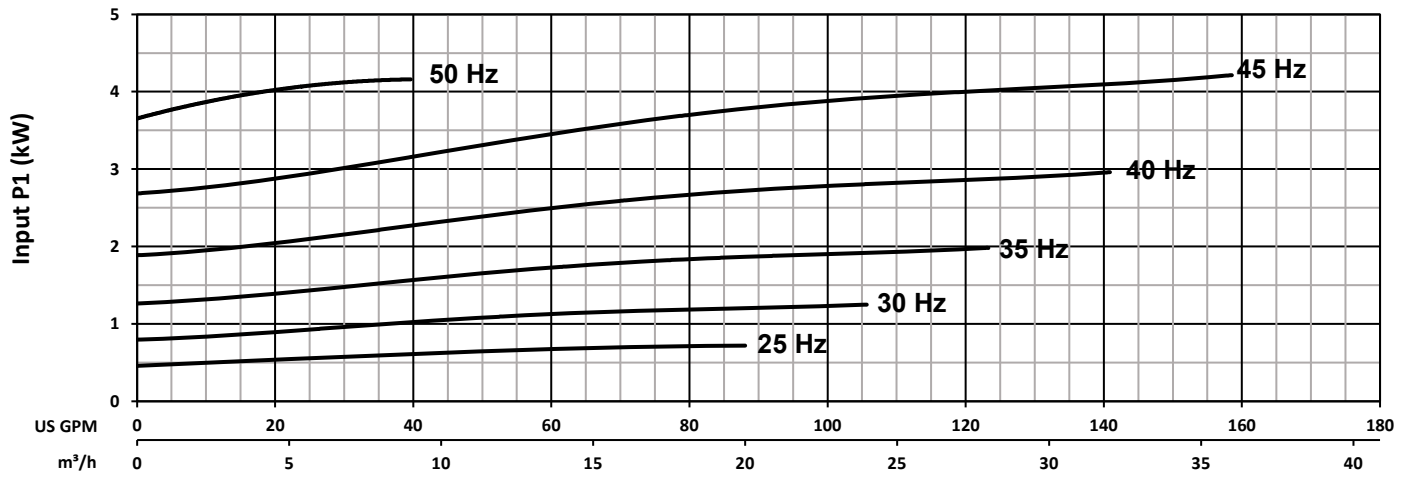
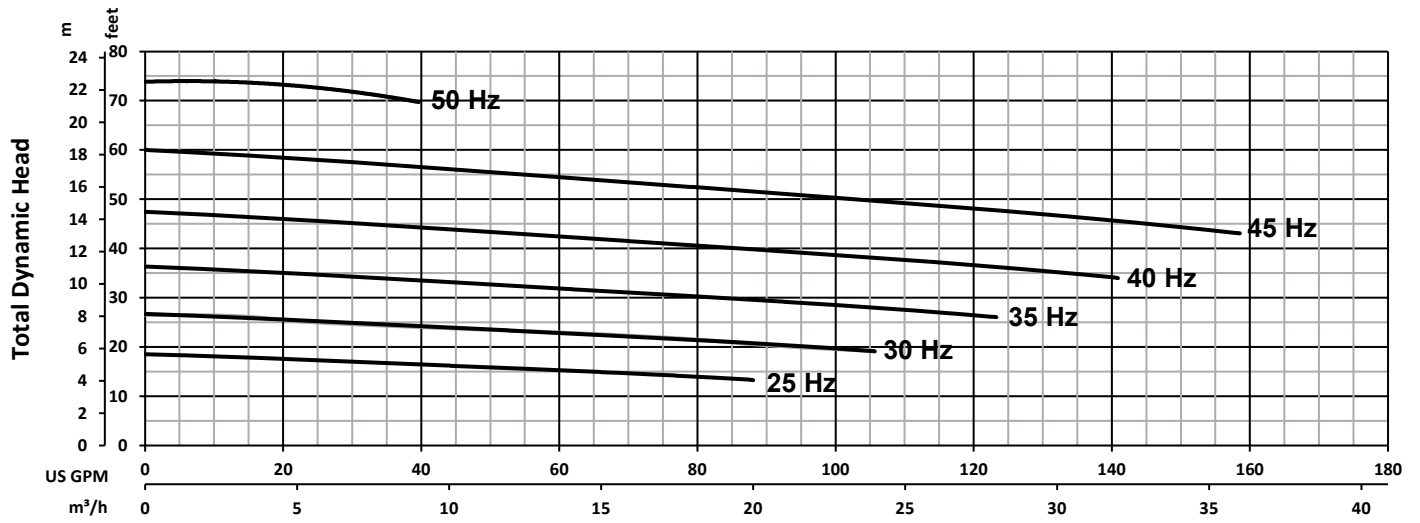

PERFORMANCE CURVE OW21-2VV 4.0kW

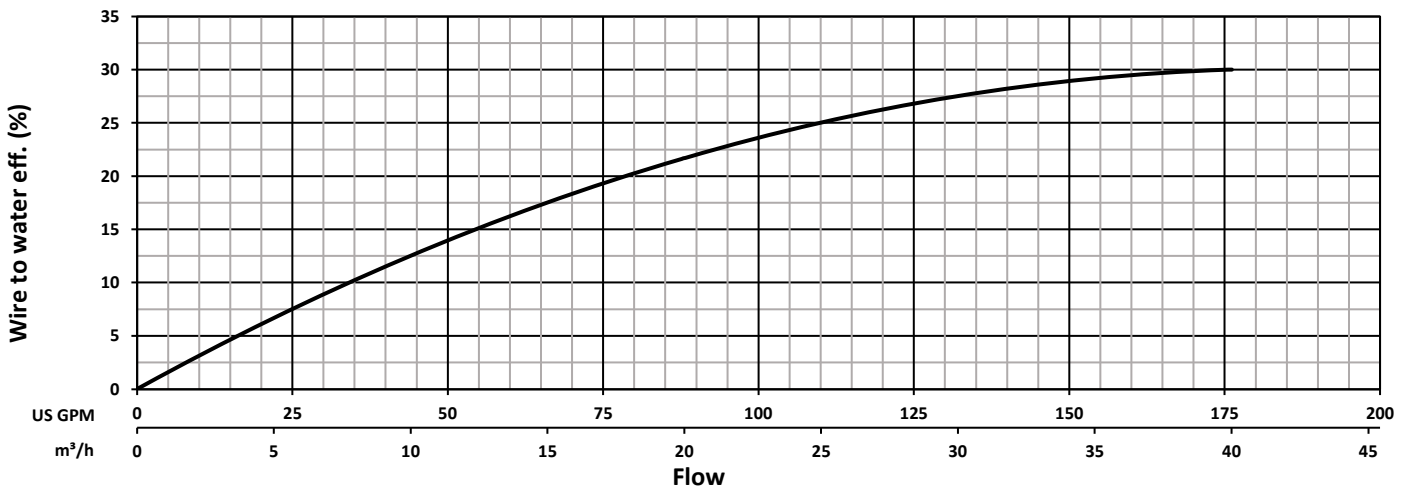
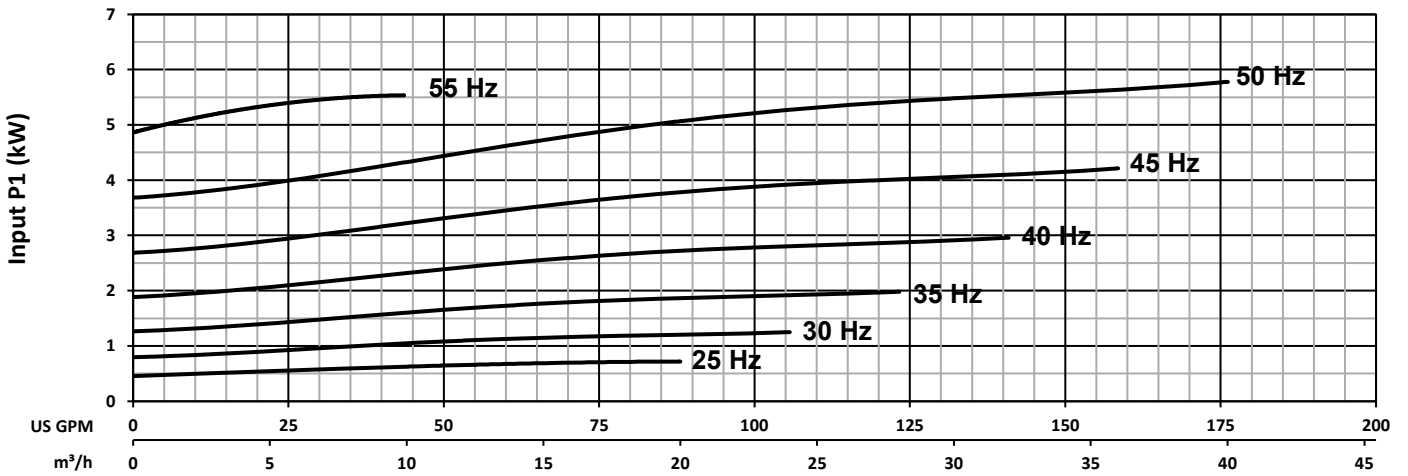
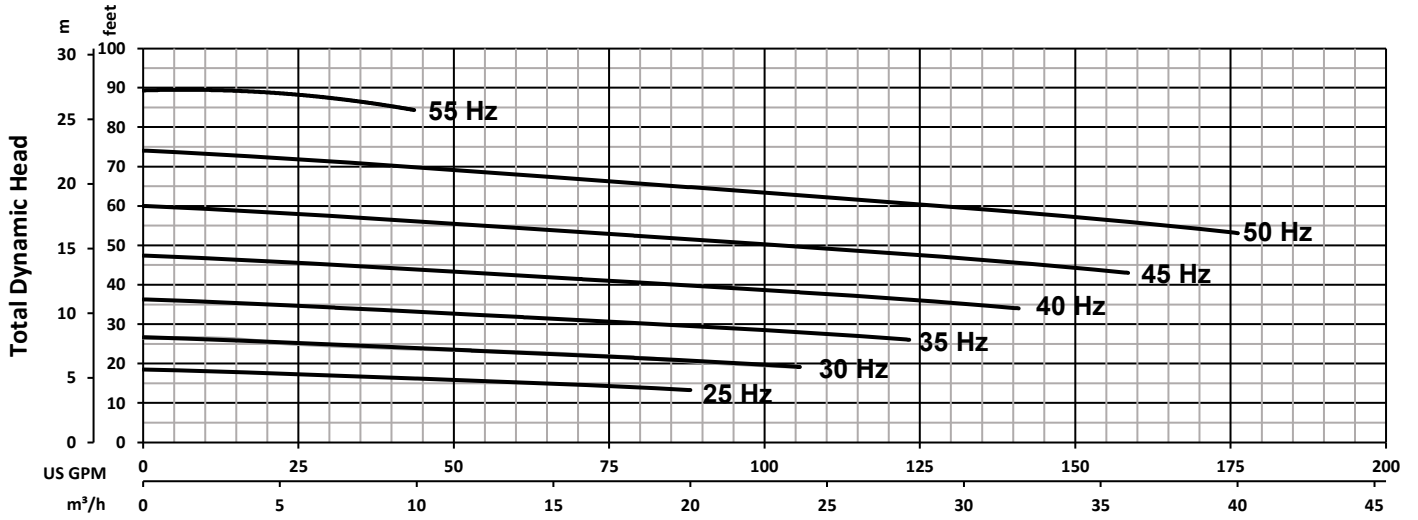

 INDUSTRIAL FLOW SOLUTIONS	PERFORMANCE CURVE			DS-A50-003
	Tested with clean water Test Standard : HI 11.6 Gr 3B		Model OW21-2VV 4.0kW	Rev --
			Motor 4.0kW / 5.4HP	Poles 2
			Impeller Ø 130mm	Date 2/27/2020
Specifications subject to change without notice				

PERFORMANCE CURVE OW21-2VV 5.5kW



 INDUSTRIAL FLOW SOLUTIONS	PERFORMANCE CURVE			DS-A50-004
	Tested with clean water Test Standard : HI 11.6 Gr 3B		Model OW21-2VV 5.5kW	Rev 1
	Motor	5.5 kW/7.4 HP	Poles 2	Date 5/5/2020
	Impeller Ø	130mm	Specifications subject to change without notice	

PERFORMANCE CURVE OW21-4VV 2.2kW

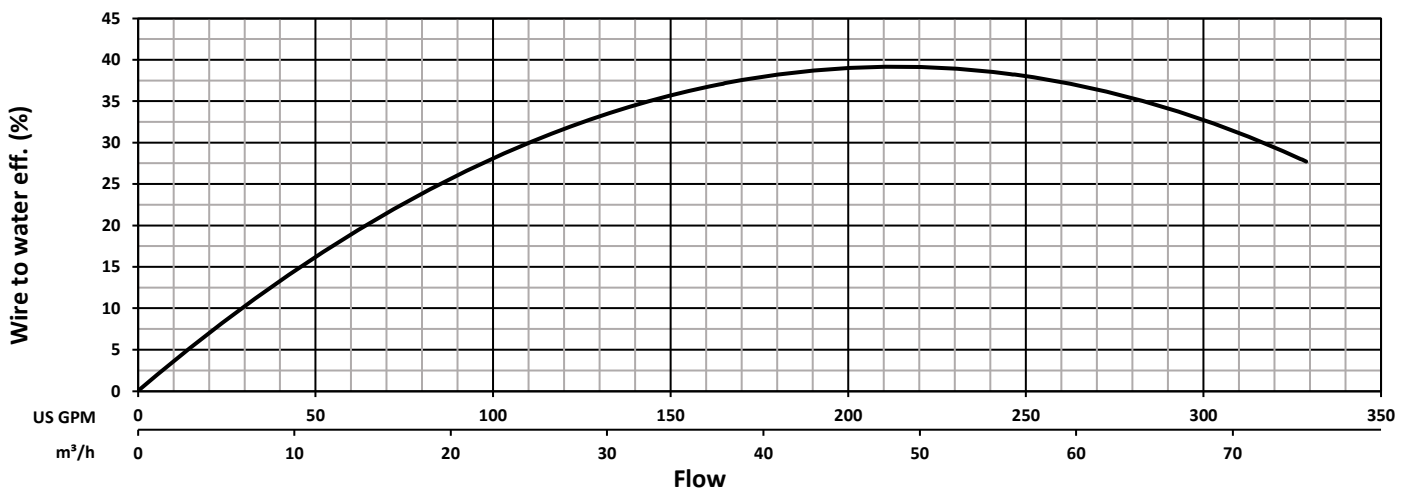
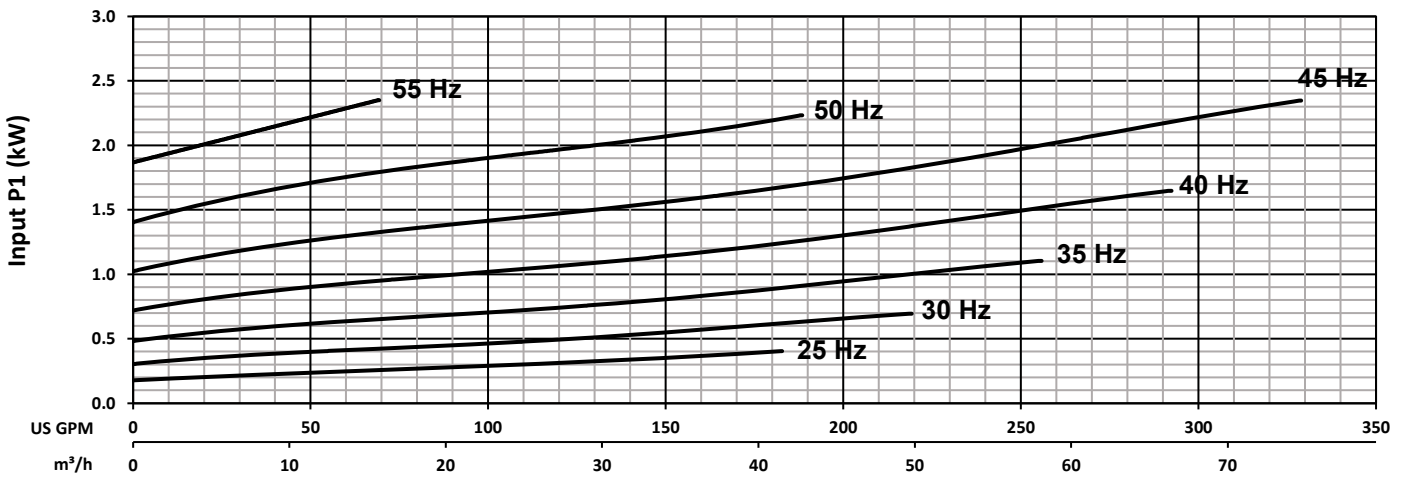
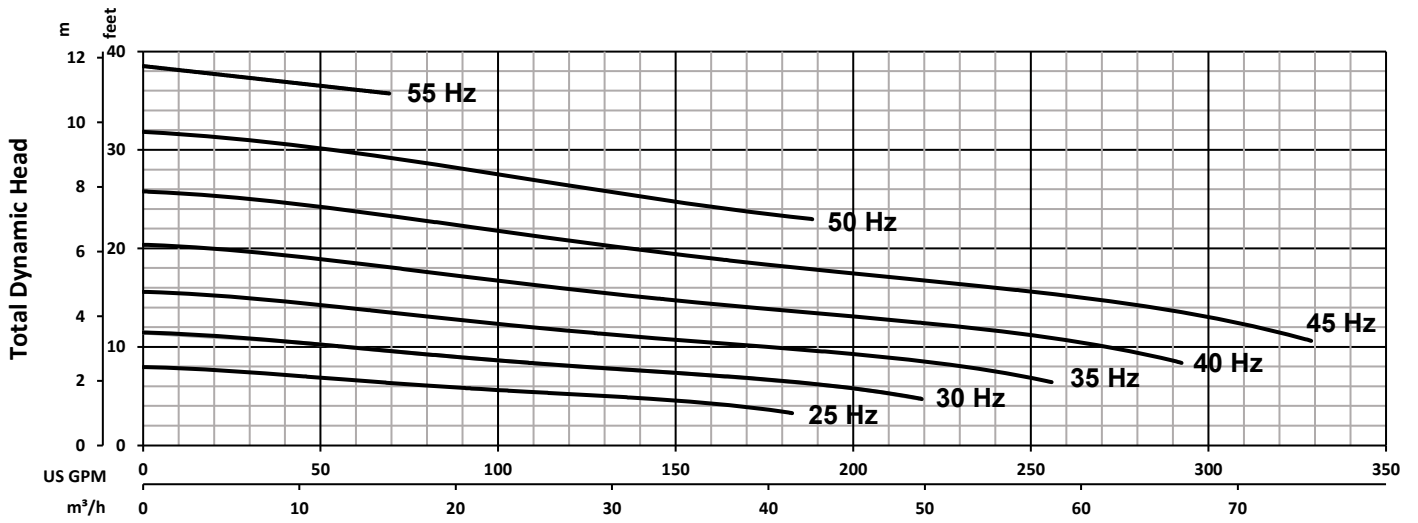

 INDUSTRIAL FLOW SOLUTIONS	PERFORMANCE CURVE			DS-A50-005	
	Tested with clean water Test Standard : HI 11.6 Gr 3B	Model	OW21-4VV 2.2kW		Rev --
		Motor	2.2 kW/3 HP	Poles 4	Date 2/27/2020
		Impeller Ø	165mm		Specifications subject to change without notice

PERFORMANCE CURVE OW21-4VV 3.0kW

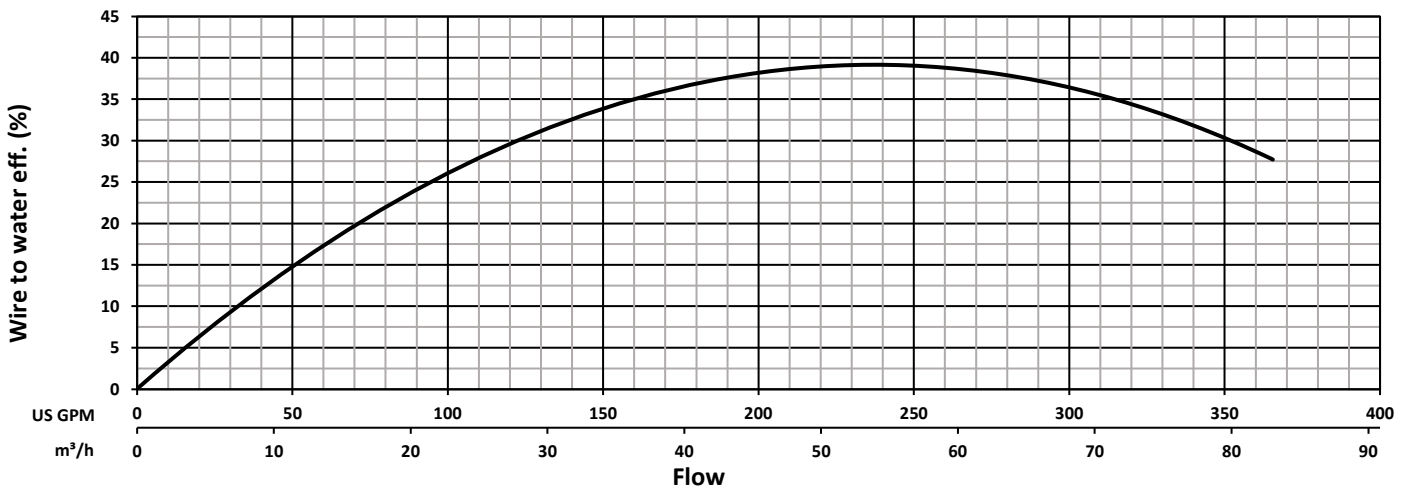
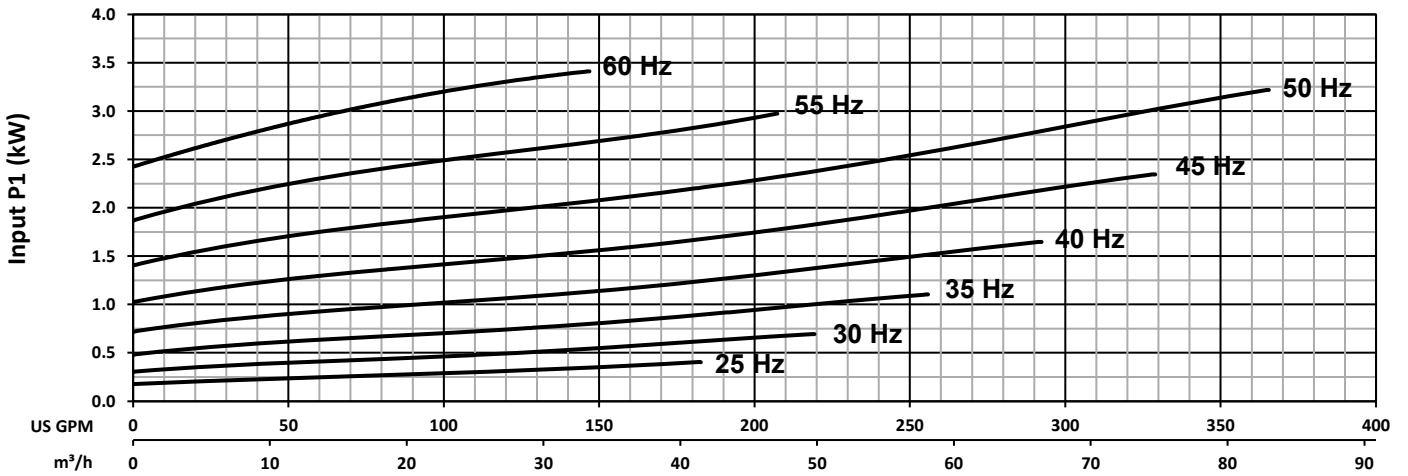
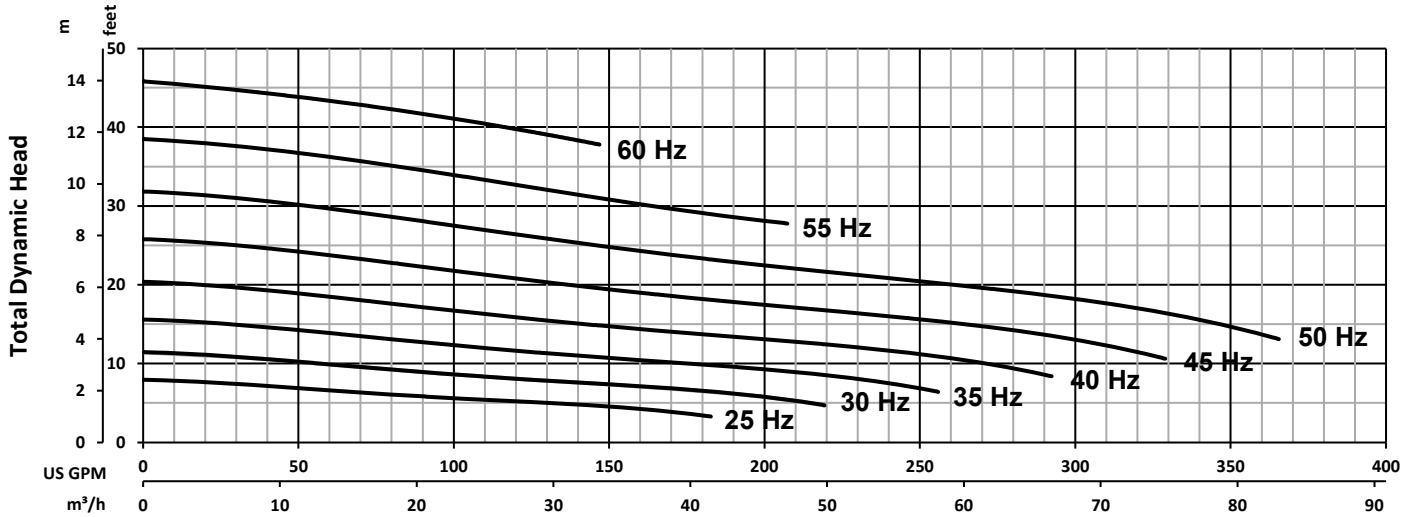

 INDUSTRIAL FLOW SOLUTIONS	PERFORMANCE CURVE			DS-A50-006	
	Tested with clean water Test Standard : HI 11.6 Gr 3B	Model	OW21-4VV 3.0kW		Rev --
		Motor	3.0 kW/4 HP	Poles 4	Date 2/27/2020
		Impeller Ø	165mm	Specifications subject to change without notice	