



INDUSTRIAL FLOW SOLUTIONS

TECHNICAL DATA

OW201/6VV

Doc #: DS-A50-074

Rev: --

Date: 4/28/2020

DESIGN / CONSTRUCTION

Body	304L SS
External Hardware	304L SS
Gaskets	Buna-N
Motor Body	Cast Iron
Shaft Seal	Single Mechanical Seal
Impeller	S4 Impeller
Maximum Solid Size \varnothing	8" (200mm)

MOTOR SPECIFICATIONS

Motor Design	6-Pole, 3-Phase Squirrel-Cage Motor 50Hz/60Hz
Motor Type	TEFC, IP67
Insulation Class	Class F
Motor Protection	Protected by VFD
Service Factor	1.15
Maximum Ambient Temp.	104°F (40°C)
Voltage Tolerance	±10%

MOTOR DATA

Rated Power	230V FLA	460V FLA	575V FLA	Weight *
15kW / 20.1HP	--	31	24.8	2160lb (982kg)
18.5kW / 24.8HP	--	36	28.8	2178lb (990kg)
22kW / 29.5HP	--	43	34.4	2222lb (1010kg)

DIMENSIONS (largest motor)

Inlet	16" ANSI 150#
Outlet	12" ANSI 150#
H1	27.2" (691mm)
H2	35.1" (892mm)
L	69.7" (1771mm)
P	67.3" (1710mm)

* Total weight of unit

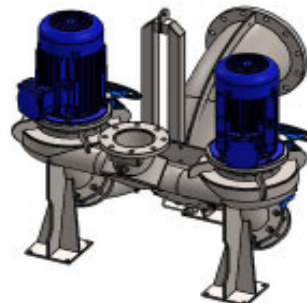
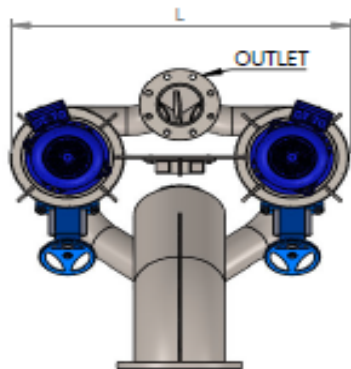
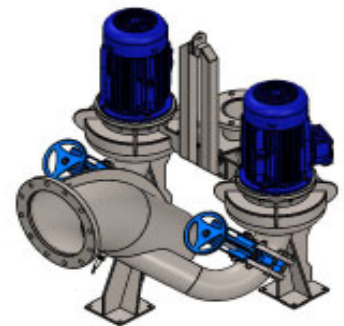
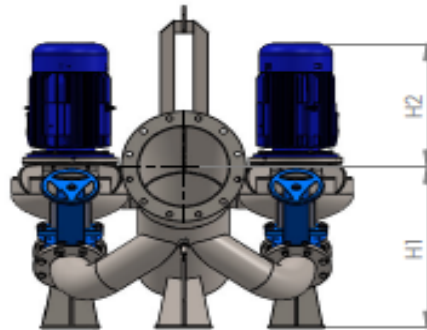
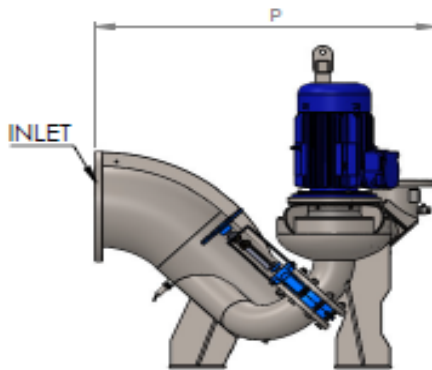

Specifications subject to change without notice

Do not use for construction purposes

PERFORMANCE CURVE OW201-4VV 75.0kW

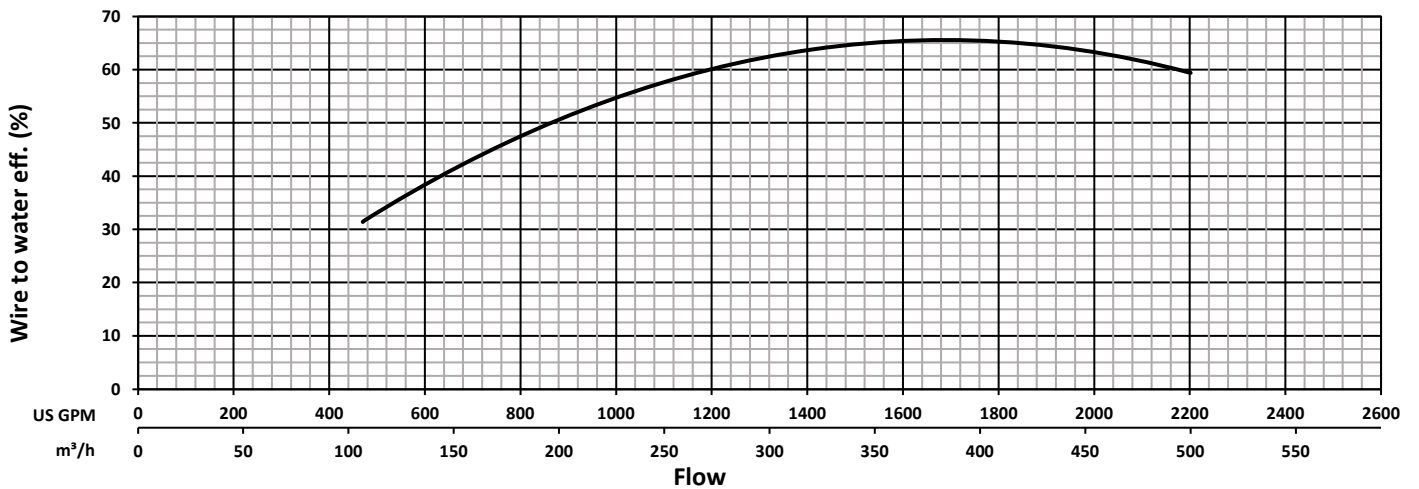
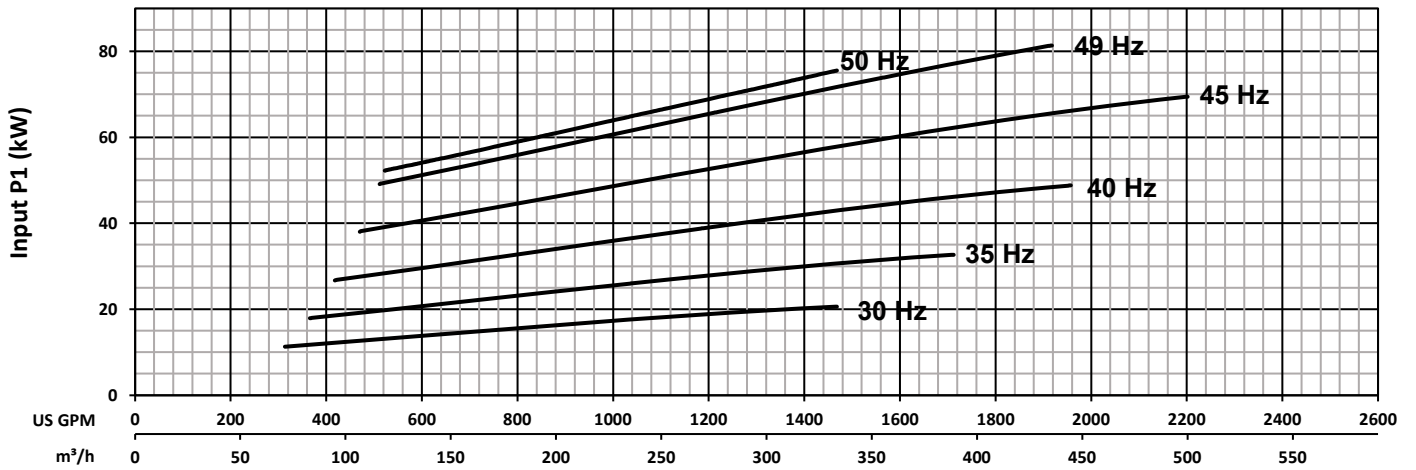
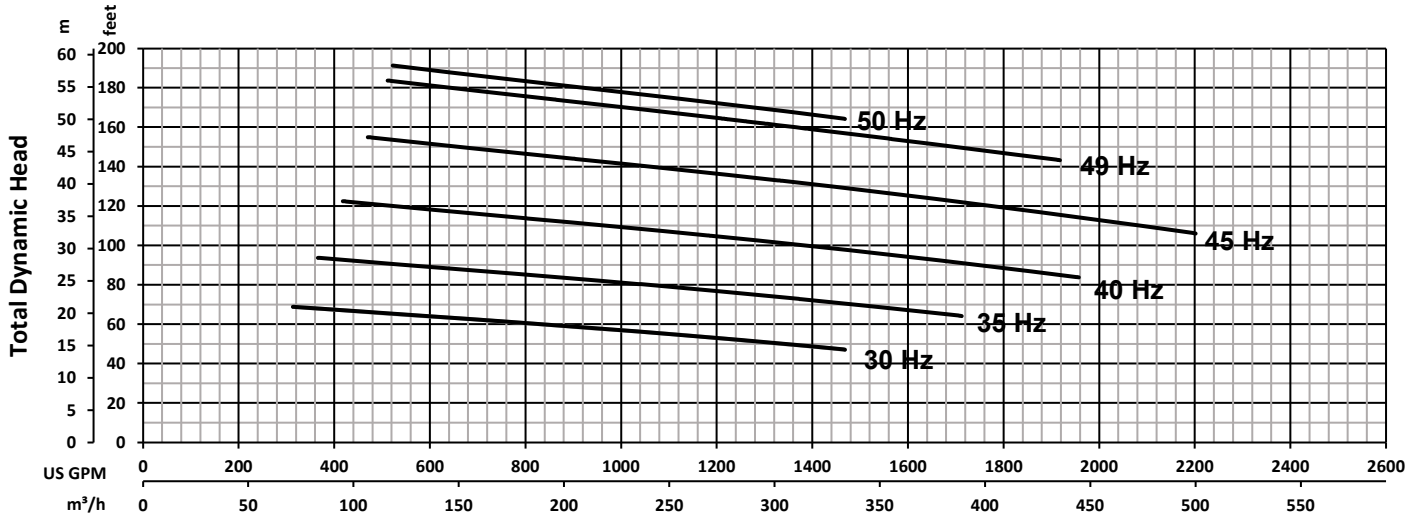

 INDUSTRIAL FLOW SOLUTIONS	PERFORMANCE CURVE			DS-A50-086	
	Tested with clean water Test Standard : HI 11.6 Gr 3B	Model	OW201-4VV 75.0kW		Rev --
		Motor	75.0 kW/100.5 HP	Poles 4	Date 6/4/2020
		Impeller Ø	S4 400mm	<small>Specifications subject to change without notice</small>	

PERFORMANCE CURVE OW201-6VV 15.0kW

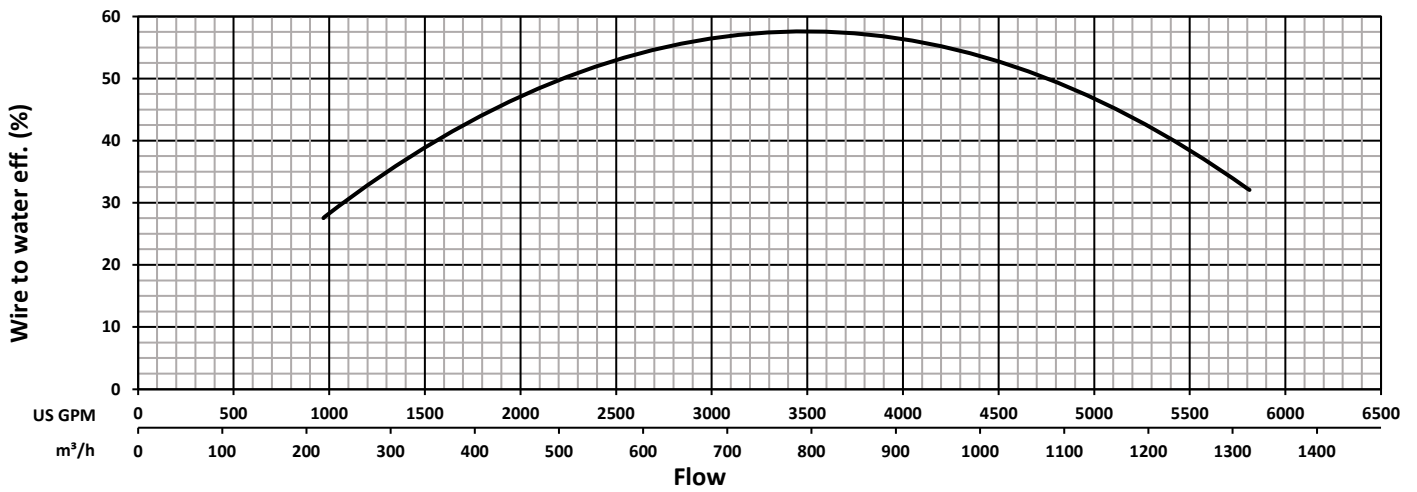
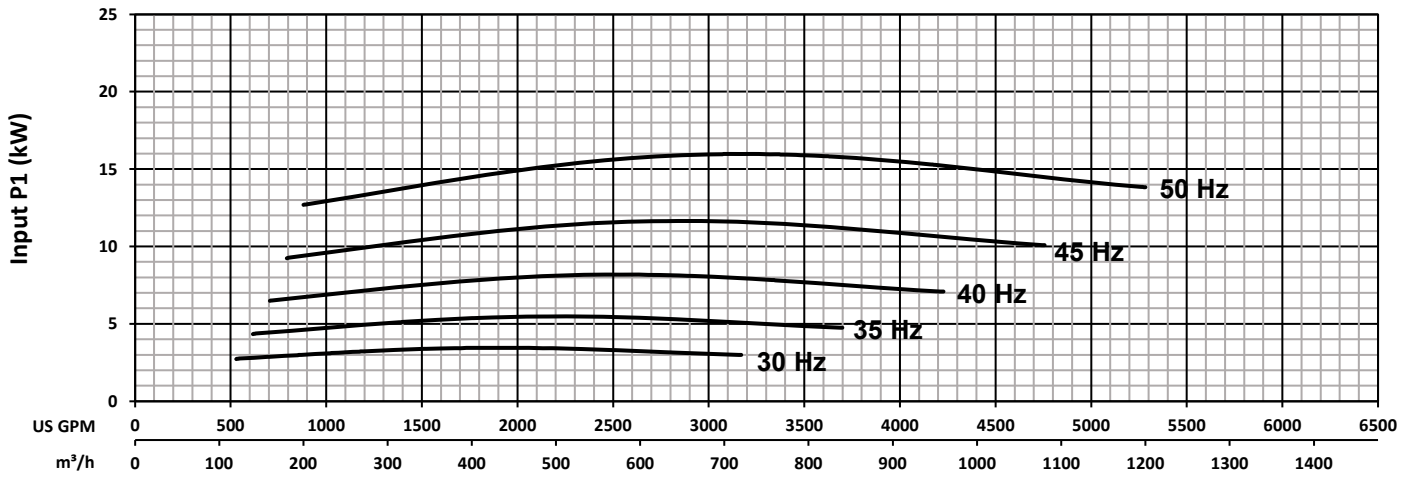
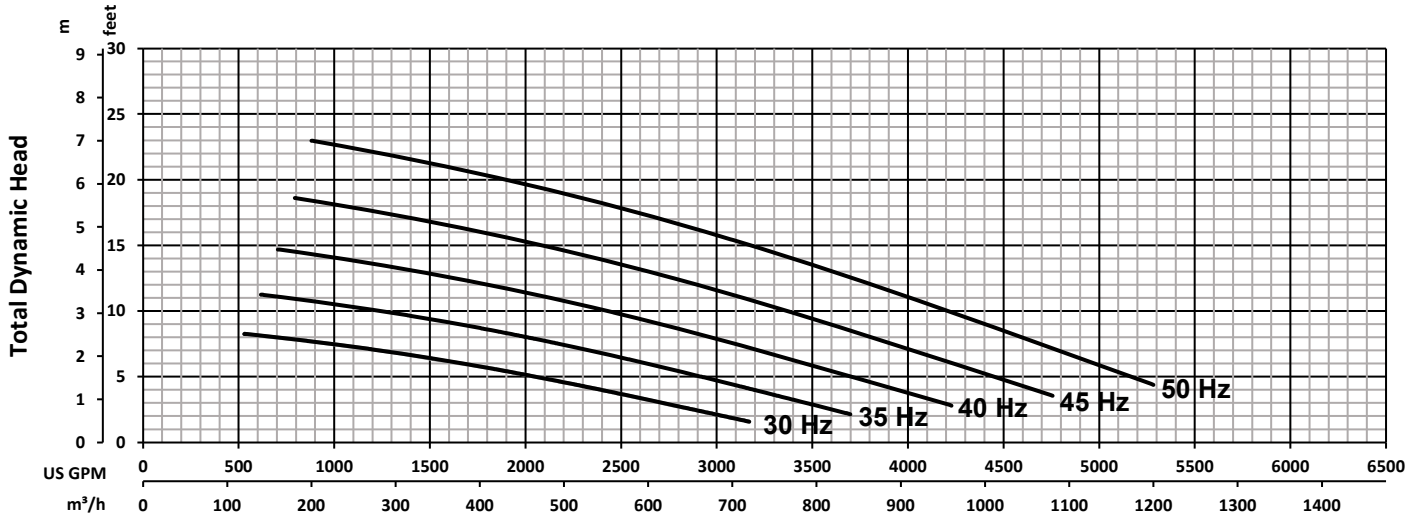

 INDUSTRIAL FLOW SOLUTIONS	PERFORMANCE CURVE			DS-A50-072	
	Tested with clean water Test Standard : HI 11.6 Gr 3B	Model	OW201-6VV 15.0kW		Rev --
		Motor	15.0 kW/20.1 HP	Poles 6	Date 4/21/2020
		Impeller Ø	S4 400mm		<small>Specifications subject to change without notice</small>

PERFORMANCE CURVE OW201-6VV 18.5kW

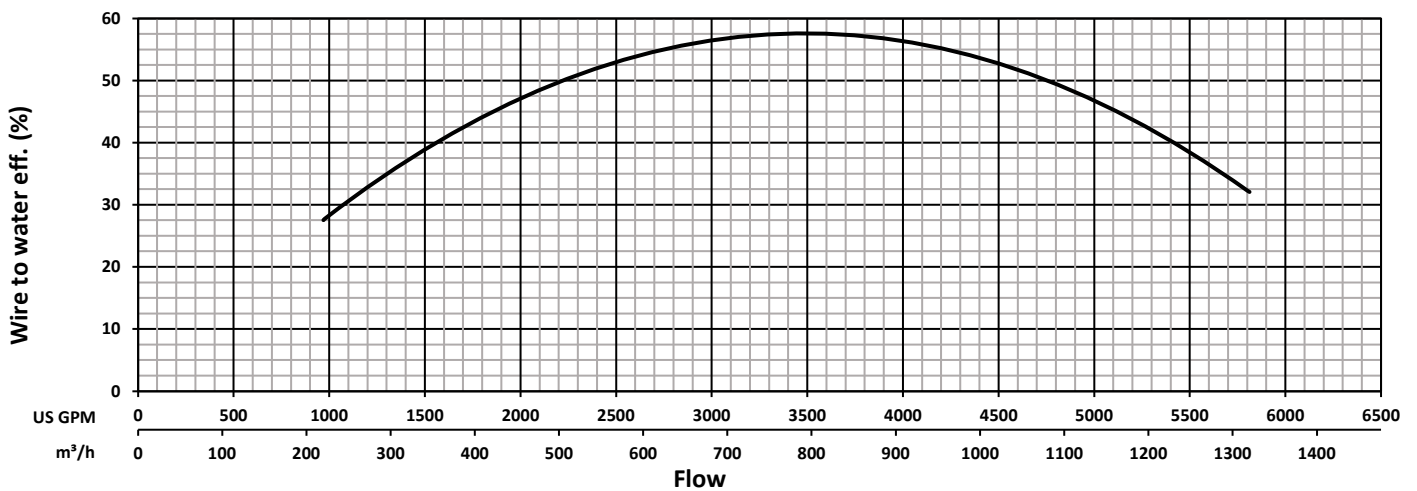
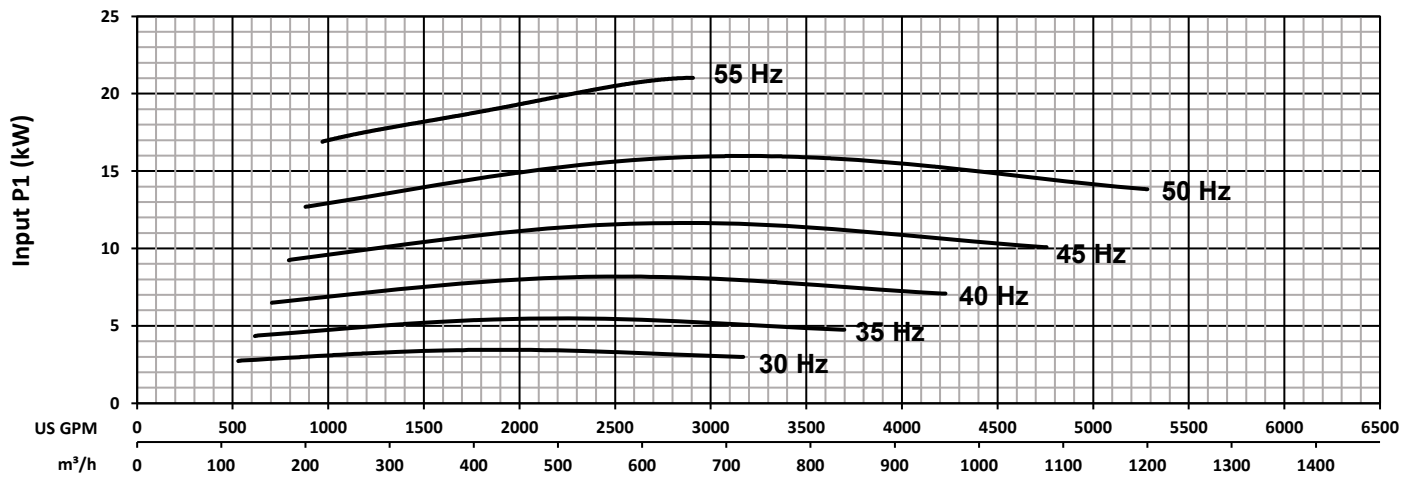
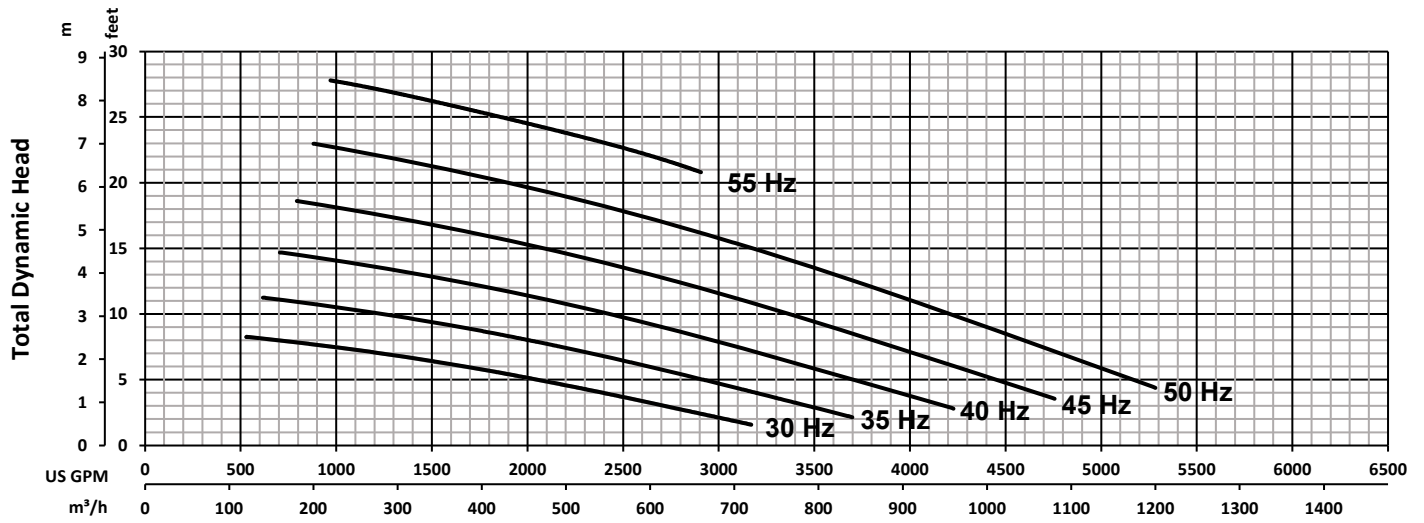

 INDUSTRIAL FLOW SOLUTIONS	PERFORMANCE CURVE			DS-A50-071	
	Tested with clean water Test Standard : HI 11.6 Gr 3B	Model	OW201-6VV 18.5kW		Rev --
		Motor	18.5 kW/24.8 HP	Poles 6	Date 4/21/2020
		Impeller Ø	S4 400mm	<small>Specifications subject to change without notice</small>	

PERFORMANCE CURVE OW201-6VV 22.0kW

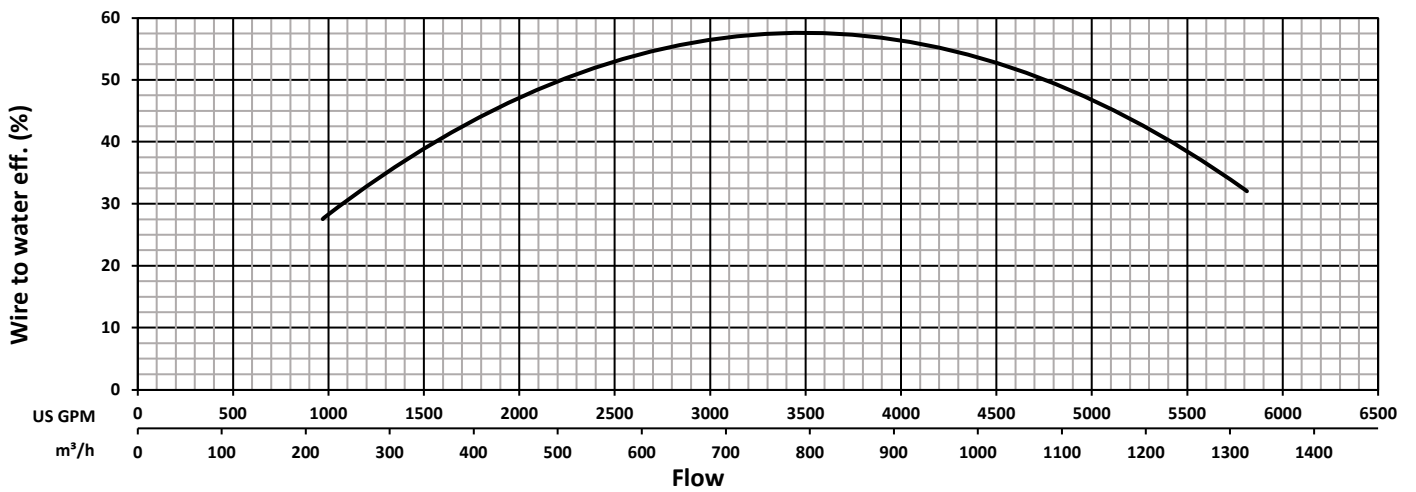
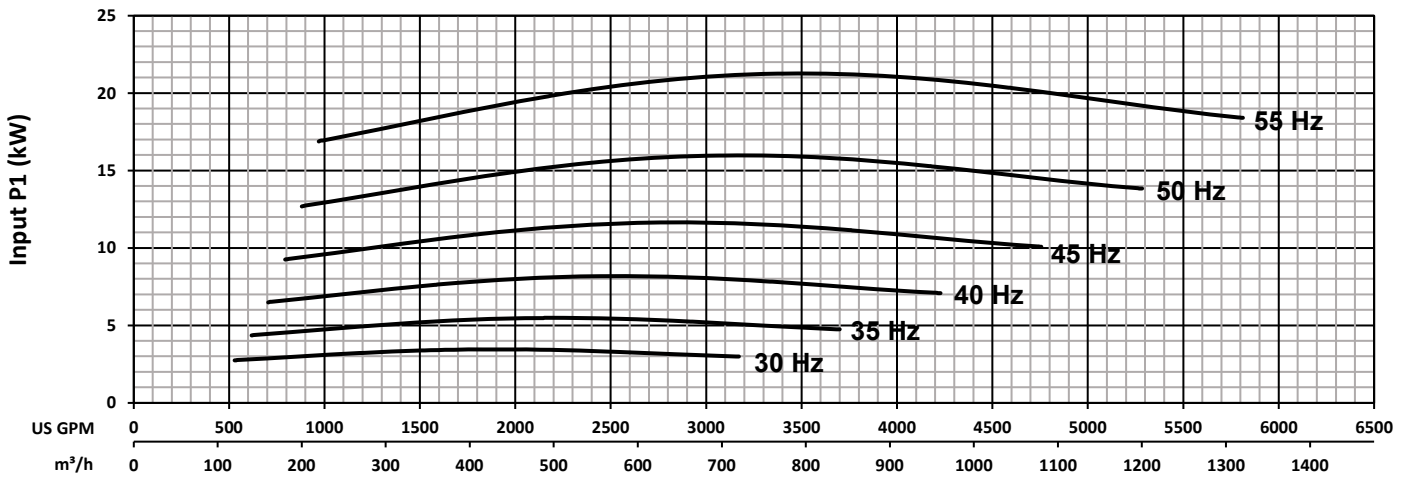
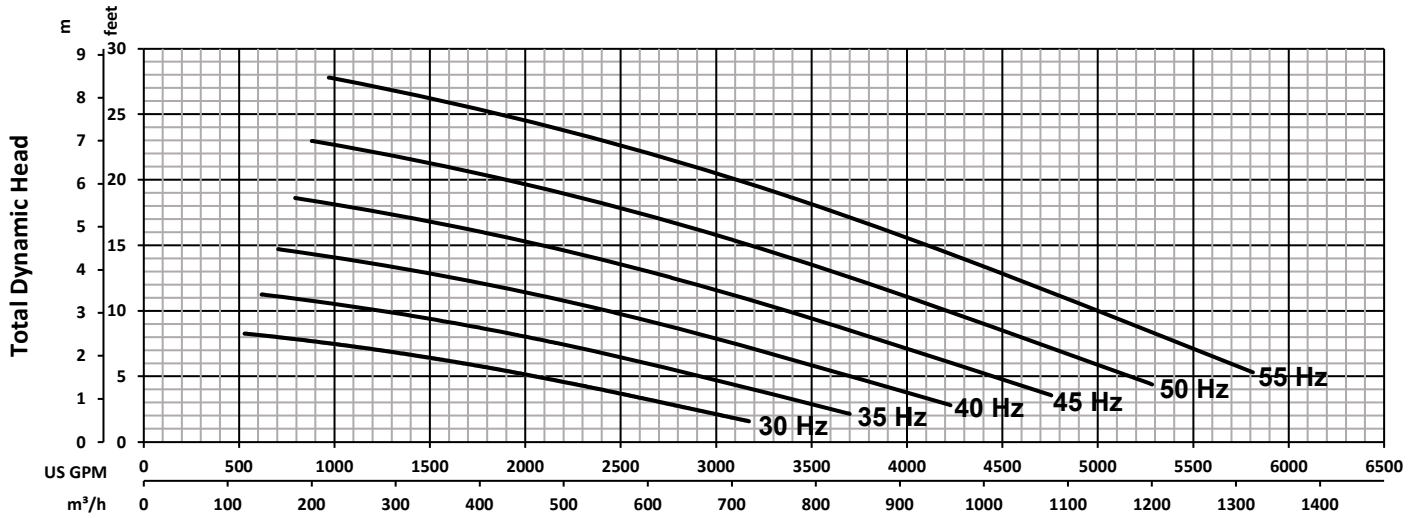

 INDUSTRIAL FLOW SOLUTIONS	PERFORMANCE CURVE			DS-A50-069	
	Tested with clean water Test Standard : HI 11.6 Gr 3B	Model	OW201-6VV 22.0kW		Rev --
		Motor	22.0 kW/29.5 HP	Poles 6	Date 4/16/2020
		Impeller Ø	S4 400mm	Specifications subject to change without notice	